



# TOWERRAID TR5UT(-B)



DETAILED USER'S MANUAL v1.0

---

# TABLE OF CONTENTS

<b>1</b>	<b>WELCOME</b>	<b>4</b>
<b>1.1</b>	<b>INTRODUCTION</b>	<b>4</b>
<b>1.2</b>	<b>PRECAUTION</b>	<b>4</b>
<b>1.3</b>	<b>FEATURES</b>	<b>5</b>
1.3.1	OVERALL FEATURES	5
1.3.2	SATA FEATURES	5
1.3.3	USB FEATURES	5
1.3.4	2 PORT eSATA 6 Gb/s PCI-E 1x 2.0 FEATURE	6
<b>1.4</b>	<b>SPECIFICATIONS</b>	<b>6</b>
<b>1.5</b>	<b>SYSTEM REQUIREMENTS</b>	<b>6</b>
1.5.1	PC SYSTEMS	6
1.5.2	MACINTOSH SYSTEMS	7
<b>1.6</b>	<b>PRODUCT CONTENTS</b>	<b>7</b>
<b>2</b>	<b>STORAGE POLICIES</b>	<b>8</b>
<b>2.1</b>	<b>CLEAN MODE</b>	<b>8</b>
<b>2.2</b>	<b>LARGE MODE</b>	<b>8</b>
<b>2.3</b>	<b>CLONE MODE</b>	<b>9</b>
<b>2.4</b>	<b>R0 MODE</b>	<b>10</b>
<b>2.5</b>	<b>R1 MODE</b>	<b>10</b>
<b>2.6</b>	<b>R10 MODE</b>	<b>11</b>
<b>2.7</b>	<b>R3 MODE</b>	<b>11</b>
<b>2.8</b>	<b>R5 MODE</b>	<b>12</b>
<b>3</b>	<b>INSTALLATION</b>	<b>14</b>
<b>3.1</b>	<b>INSTALLING HARD DISK DRIVE</b>	<b>14</b>
<b>3.2</b>	<b>POWER ON / OFF</b>	<b>15</b>
<b>3.3</b>	<b>INSTALLING SATA TO eSATA BRACKET CABLE</b>	<b>16</b>
<b>3.4</b>	<b>INSTALLING HOST BUS ADAPTER</b>	<b>16</b>
<b>4</b>	<b>CONFIGURATION</b>	<b>17</b>
<b>4.1</b>	<b>CONFIGURATION PREREQUISITES</b>	<b>17</b>
4.1.1	SATA HOST CONNECTIONS	17
4.1.2	USB HOST CONNECTIONS	17
<b>4.2</b>	<b>CHANGING HOST CONNECTIONS</b>	<b>17</b>
<b>4.3</b>	<b>DISCONNECTING A USB DEVICE</b>	<b>17</b>
4.3.1	WINDOWS SYSTEMS	17
4.3.2	MACINTOSH SYSTEMS	17
<b>4.4</b>	<b>HARD DISK DRIVE HOT-PLUG &amp; HOT-UNPLUG</b>	<b>18</b>
<b>4.5</b>	<b>LED INDICATIVE STATUS</b>	<b>18</b>
4.5.1	POWER LED	18
4.5.2	PC LINK LED	18
4.5.3	HARD DISK DRIVE LED	18
<b>4.6</b>	<b>MODE SETTING</b>	<b>19</b>
4.6.1	CLEAN MODE	19
4.6.2	LARGE MODE	20

4.6.3	CLONE MODE .....	21
4.6.4	CLONE MODE WITH HOT SPARE .....	22
4.6.5	R0 MODE .....	24
4.6.6	R1 MODE .....	25
4.6.7	R1 MODE WITH HOT SPARE .....	26
4.6.8	R10 MODE.....	28
4.6.9	R10 MODE WITH HOT SPARE .....	29
4.6.10	R3 MODE.....	30
4.6.11	R3 MODE WITH HOT SPARE.....	31
4.6.12	R5 MODE.....	33
4.6.13	R5 MODE WITH HOT SPARE.....	34
<b>4.7</b>	<b>REBUILDING A REDUNDANCY OR HOT SPARE DRIVE.....</b>	<b>36</b>
4.7.1	REBUILDING A REDUNDANCY DRIVE.....	36
4.7.2	REBUILDING A HOT SPARE DRIVE .....	38
<b>5</b>	<b><u>PARTITIONING VOLUMES .....</u></b>	<b><u>40</u></b>
<b>5.1</b>	<b>PARTITION A VOLUME .....</b>	<b>40</b>
5.1.1	WINDOWS SYSTEMS.....	40
5.1.2	MACINTOSH SYSTEMS.....	45
<b>6</b>	<b><u>APPENDIX .....</u></b>	<b><u>48</u></b>
<b>6.1</b>	<b>FAQ.....</b>	<b>48</b>
<b>6.2</b>	<b>HARD DISK DRIVE COMPATIBILITY LIST .....</b>	<b>48</b>
<b>6.3</b>	<b>MOTHERBOARD COMPATIBILITY LIST.....</b>	<b>50</b>

---

# I WELCOME

## I.1 INTRODUCTION

Thank you for choosing *TowerRAID TR5UT/TR5UT-B* storage appliance. It is a hardware RAID solution for digital home and small office storage appliances. Features of the *TowerRAID TR5UT/TR5UT-B* include advanced RAID modes. It's available from leading storage partners in pre-configured set-ups with USB or eSATA host connections. Simply connect the appliance with an appropriate USB or eSATA cable to the USB host or PCIe 1x controller card. eSATA bracket cable is provided to connect to motherboard if no PCIe slot available.

The *TowerRAID TR5UT/TR5UT-B* storage appliance are available in eight different configurations (Clean, Large, Clone, R0, R1, R10, R3 and R5), each offering a different application of features and capabilities.

The *TowerRAID TR5UT/TR5UT-B* Storage Processors are powered by a RAID controller chip, 1 to 5-ports Serial ATA II Port Multiplier with RAID function support. It is designed to provide SATA port expansion, data protection and performance aggregation at various applications. It is a self-contained storage processor chip which completely frees up the main CPU loading and the SATA ports comply with eSATA specification, the USB ports comply with Hi-Speed USB specification, making it suitable for use in external storage applications.

The *TowerRAID TR5UT/TR5UT-B* storage appliance uses industry-proven Multi-port Serial ATA PHY technology and storage processor to provide very high efficient SATA RAID operation.

With an easy configuration scheme, the device can be a pure port-multiplier which provides SATA port expansion just like a SATA Hub, or hard-drive performance booster which provides a high performance device seen by host controller or hard-drive data protector which automatically backup data to prevent data loss from hard-drive damage. *TowerRAID TR5UT/TR5UT-B* storage appliance also has advance mode to provide both benefit of performance boost and data protection.

The *TowerRAID TR5UT/TR5UT-B* storage appliance architecture which provides:

- Fully hardware-accelerated RAID Engine.
- No driver, BIOS or software required for RAID operation.
- Independent of device SATA port connection sequence.
- Rebuild proceeds continuously between power cycling.
- Supports on-line read data integrity check.
- Supports on-line command based bad sector recovery.
- Supports disk modes: Clean, Large, Clone.
- Supports RAID levels: 0, 1, 3, 5, 10.
- RAID 3 / 5 write-back cache to enhance performance.
- Supports Auto-Rebuild on Clone, R1, R3, R5, R10.
- Supports Hot-Spare on Clone, R1, R3, R5, R10.
- Rebuild speed: 200GB/hour.
- Supports various RAID configuration methods.

## I.2 PRECAUTION

Please read the safe precautions carefully before you using *TowerRAID TR5UT/TR5UT-B* storage appliance. Ensure that you use the product correctly according to the procedure described in this guide.

The following safety precautions are intended to remind you to operate the product safely and correctly. Please read and ensure that you understand them before you proceed to the other sections of this guide.

- **Do not plug any HDD(s) while power is on (except operation in CLEAN MODE).**
- Do not attempt to disassemble or alter any part of the product that is not describe in this guide.
- Do not allow the product to come into contact with water or other liquids. In the event that water or other liquids enter the interior, immediately unplug the product from the computer. Continued use of the product may result in fire or electrical shock. Please consult your product distributor or the closest support center.
- Do not handle the product near a heat source or expose them to direct flame or heat.
- Never place the product in close to equipment generating storage electromagnetic fields. Exposure to strong magnetic fields may cause malfunctions or corrupt data.
- The product does nto support under Windows 3.x/ 95 / 98SE/ ME/ NT.

- Hard disk drive is not including, unless state otherwise.
- Please be noted the following product may run irregularly which are not under warranty.
  - ✓ Toshiba DynaBook, Satellite series (All K6 CPU models).
  - ✓ IBM Aptiva E series (All K6 CPU models).
  - ✓ Sotec E-note M260 series.
  - ✓ All AMD K6 system.
  - ✓ PC with sis7000/ 7001/ 7002 PCI to USB host controller.

## 1.3 FEATURES

### 1.3.1 OVERALL FEATURES

- Provides Clean, Large, Clone, R0, R1, R3, R5, R10 modes for effective storage management.
- Easy configuration of RAID modes, no IT expertise required.
- Easy monitoring of system status via LED indicators.
- Ensures data integrity with redundant backup capability.
- Achieves fastest performance via R0 mode.
- Supports automatic rebuild in Clone, R1, R3, R5, R10 mode.
- Supports hot spare drive in Clone, R1, R3, R5, R10 mode.
- Supports HDD roaming.
- Supports current SATA II compliant HDDs, backward compatible with most SATA I compliant HDDs.
- Simplifies HDD installation; user friendly design enables effortless HDD swapping.
- Flexible connection via eSATA or USB host port.
- Eliminates potential downtime, repair costs, and lost sales due to disk failure.
- Dissipates heat efficiently with metal housing.
- Maximizes airflow with silent, high quality fan.
- 1 host port (eSATA or USB) to 5 Serial ATA hard disk drives.
- Compatible with SATA Gen I and Gen2 host controllers.
- Compatible USB 2.0 specifications.
- Embedded fast Storage Processor.
- Ultra-fast 3Gbps host and device port capability.
- Greater than 200MBps sustained reads in R0 mode (limited by drives and host controller).

### 1.3.2 SATA FEATURES

The *TowerRAID TR5UT/TR5UT-B* provides the following Serial Advanced Technology Attachment (SATA) features:

- 1 eSATA host port to 5 SATA devices (Port Multiplier Functionality).
- Auto-negotiation between SATA I (1.5Gpbs) and SATA II (3Gpbs).
- Supports SATA II Gen2i and Gen2m (External SATA Connection, eSATA).
- Supports Hot-Plug on CLEAN MODE.
- Supports Native Command Queue (NCQ).
- Supports PM aware and non-PM aware host on RAID mode.
- Supports asynchronous signal recovery.
- Supports spread spectrum clocking.
- Supports BIST and loopback mode.
- Supports 48-bit LBA addressing.
- Supports ATAPI drives.
- Supports host control of hard disk drive staggered spin-up.
- Supports Asynchronous Notification.
- Output swing control and automatic impedance calibration for SATA II PHY.

### 1.3.3 USB FEATURES

The *TowerRAID TR5UT/TR5UT-B* provides the following Universal Serial Bus (USB) features:

- 1 USB 2.0 host port to 5 SATA devices.
- Operates at USB full and High-speed rates (12 ~ 480Mb/s).
- OS independent, Driverless, Auto Configuration.
- Support USB High-Speed and Full-Speed Operation.
- Supports and compatible with OHCI/UHCI/EHCI hosts.
- Support Mass Storage Class.
- Support on line USB firmware update.

- Compliance with USB 2.0 electrical specification.
- Compliance with USB Mass Storage Class, Bulk-Only Transport Specification.

### 1.3.4 2 port eSATA 6 Gb/s PCIe 1x 2.0 Feature

The TowerRAID TR5UT/TR5UT-B bundled with Highpoint R622 host bus adapter.

- PCI-Express 2.0 x1 (Compatible with PCI-Express 1.0)
- Serial ATA III (6.0Gbps) compliant, with speed negotiation
- Serial ATA II (3Gbps) and Serial ATA I (1.5Gbps)
- 600MB/s per (SATA and eSATA) port Industry
- Standard AHCI Compliant Hot-plug capability
- Supports Native Command Queuing (NCQ)
- Out-of-the-Box Ready for Windows, Linux and Mac OS X 10.6 and above (Check AHCI detail OS support)
- Compatible with SATA (III, II, I) Hard Drives, SSD, et
- Support up to 2TB Hard Drives Power Efficient – Going Green Saves Green RoHS compliant

## 1.4 SPECIFICATIONS

- Five 3.5-inch SATA HDDs to a standard B type USB or eSATA interface with HDD trays and door cover.
- Power, PC Link, and five HDD LEDs.
- Hardware RAID design to eliminate OS compatibility and other related issues
- Support Clean, Large, Clone, R0, R1, R3, R5, R10 modes.
- Metal chassis (SECC) and plastic panel frame (ABS) design.
- 282 (L) x 150 (W) x 215 (H) mm, NW: 4.1 Kgs, GW: 5.3Kgs.
- 250 watts power supply, 100 to 132Vac or 200 to 264Vac select switch / 47~63Hz with CE/ FCC/ UL/ CB/ BSMI requirement. Physical Dimensions: 154 mm (L) x 82 mm (W) x 42.5 mm (H).

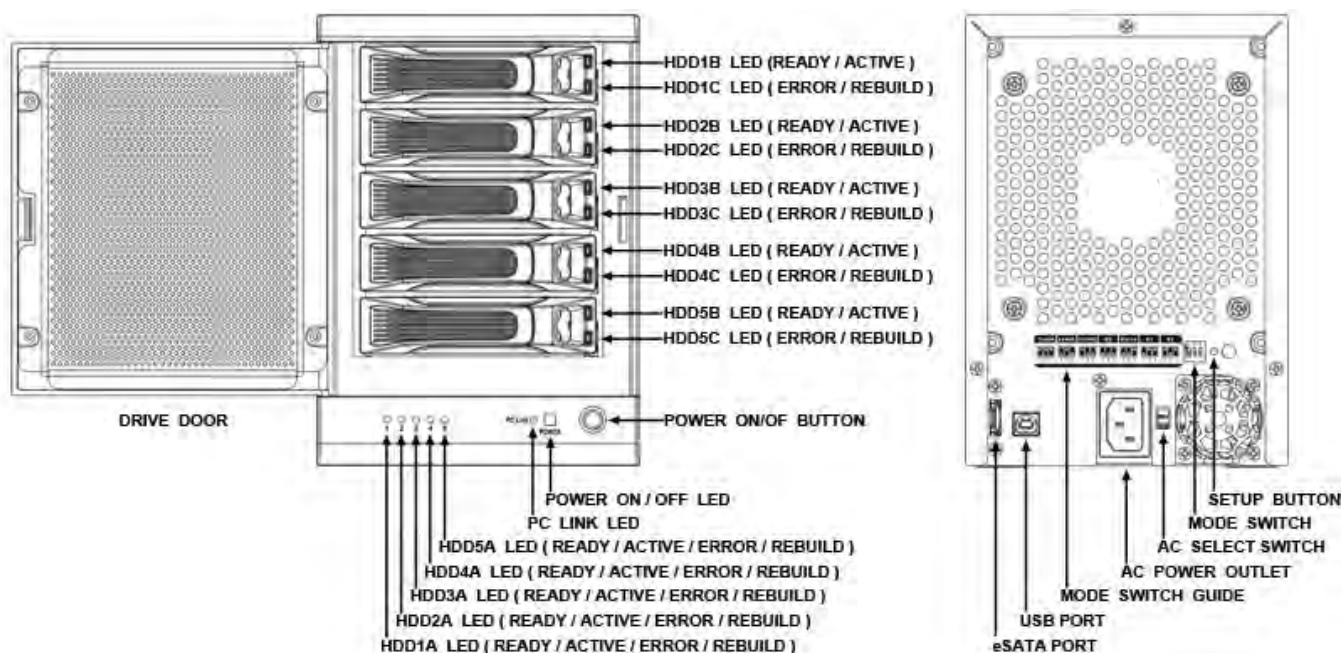

## 1.5 SYSTEM REQUIREMENTS

### 1.5.1 PC SYSTEMS

- Intel Pentium-III 500MHz equivalent or faster
- Windows XP, Windows Vista, Windows 7, Windows Server 2003/2008 with the latest Service Packs
- CD-ROM drive
- 64 MB of RAM (minimum)
- 250 MB of free disk space
- Super VGA (800 x 600) or higher resolution display with at least 256 colors
- Mouse or compatible pointing device
- eSATA port for eSATA connection

- USB connection: USB 1.0 or 2.0 direct host connection or USB hub

### 1.5.2 MACINTOSH SYSTEMS

- Mac Pro
- Mac OS Tiger 10.4.x
- Mac OS Leopard 10.5.x
- Mac OS Snow Leopard 10.6.x
- CD-ROM drive
- Mouse or compatible pointing device
- eSATA port for eSATA connection
- USB connection: USB 1.0 or 2.0 direct host connection or USB hub

## 1.6 PRODUCT CONTENTS

The following parts are content.

- TR5UT/TR5UT-B x 1.
- HDD Tray x 5.
- USB 2.0 Cable x 1.
- eSATA Cable x 1.
- Power Cable x 1.
- HDD Screw x 20.
- Setup and Installation Driver CD x 1.
- SATA to eSATA Bracket Cable x 1.
- PCI-Express 1x HBA x 1.

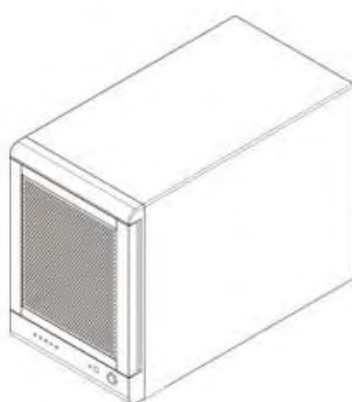

**TERA STOR SATA RAID III**



**HDD Tray**

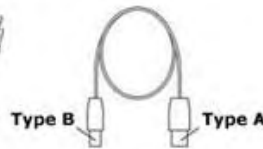

**USB Cable**



**eSATA Cable**



**Power Cable**



**HDD Screw**



**Setup and Installation Driver Repository CD**

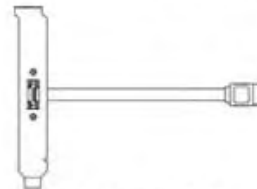

**SATA to eSATA Bracket Cable**

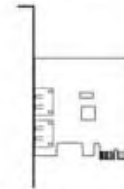

**PCI-Express HBA (OPTIONAL)**

---

## 2 STORAGE POLICIES

You can configure the *TowerRAID TR5UT/TR5UT-B* storage appliance to use any of the following storage policies to map the appliance's physical hard drives to virtual drives that are visible to the host computer. The virtual drives are called **volumes**. The host operating system treats each volume as if it were a single physical drive. This virtualization allows you to overcome restrictions that are imposed by physical hard drives, such as speed, storage capacity or data storage reliability.

### 2.1 CLEAN MODE

The CLEAN MODE storage policy enables each hard drive to be seen separately as one drive. When using a SATA host controller, CLEAN MODE should only be used if the SATA host controller provides Port Multiplier (PM) support. If a host is not PM-aware, only a single drive is presented (drive 1). No such limitation if using a USB host connection.

The CLEAN MODE storage policy is available for a standalone (non-cascaded) storage or the top-level node of a cascaded configuration, but not for subordinate nodes. Even though you can use the MODE SWITCH to select CLEAN MODE for any node in a cascaded configuration, only the first CLEAN MODE volume of any subordinate node is detected by your host. Therefore, selecting CLEAN MODE for any subordinate node is not recommended.

In a CLEAN MODE configuration, the *TowerRAID TR5UT/TR5UT-B* storage appliance directly exposes each physical drive. The CLEAN MODE will not clean up the drives partition if the drives were use as single drive before.

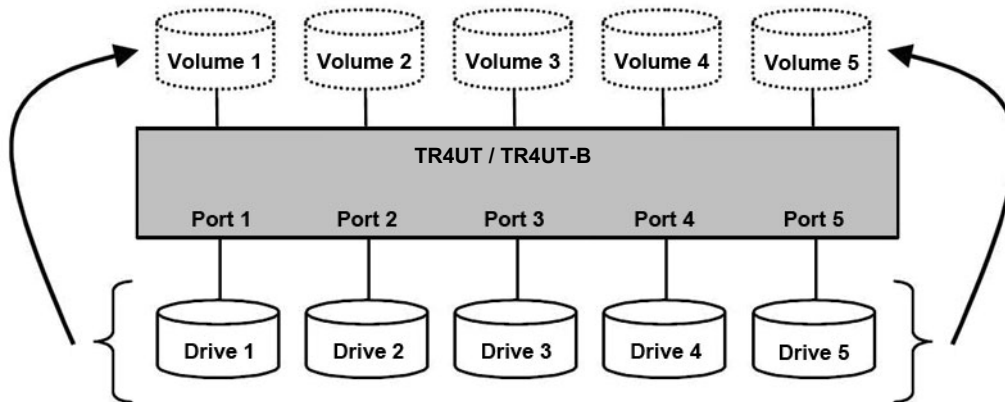

Figure: CLEAN MODE storage policy sample configuration.

### 2.2 LARGE MODE

The LARGE MODE storage policy concatenates a series of physical hard drives as a single large volume; resulting in a seamless expansion of virtual volumes beyond the physical limitations of singularly connected hard drives. *TOWERRAID TR5UT/TR5UT-B* storage policy delivers maximum storage space without a single large capacity and costly hard drive.

Any node within a cascaded configuration can be set to LARGE MODE.

Hard drives 1 to 5 are concatenated into a single virtual volume in the Figure below with a storage capacity that is equal to the sum of each of the physical hard drives 1 to 5.

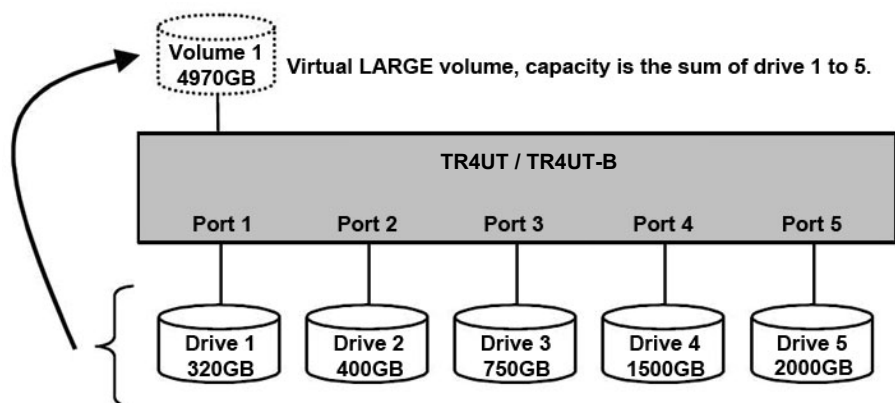

**Figure: LARGE MODE storage policy sample configuration.**

It is also possible to create a LARGE volume using only a single hard disk drive connected to Port 1. However, it is not possible to expand an existing LARGE volume by adding another hard disk drive and still preserve any existing data on that volume.

## 2.3 CLONE MODE

The CLONE MODE storage policy stores all data in duplicate on separate drives to protect against data loss due to drive failure. One drive *clones* the others at all times. Every write operation goes to all drives. CLONE MODE provides the highest level of data protection for critical data that you cannot afford to lose if a hard drive fails, but waste the amount of storage capacity because all data must be stored to all drives. The resulting storage capacity of the virtual CLONE volume will be equivalent to the size of one hard drive (if all drives are the same) or the smallest of the all drives (if they are different).

If drive fails (Maximum four drives), the CLONE volume is still usable, but it is in a vulnerable state because its cloned hard drive is inaccessible. When the offline drive comes back online, the appliance begins a rebuild process immediately one by one (if they are more than one fails) to restore data redundancy. A message appears in the LED indicator to notify you that a rebuild is in progress.

Although the volume remains available during the rebuild process, the volume is susceptible to data loss through damage to the remaining drive until redundancy is restored at the end of the rebuild and verification process. Host access takes precedence over the rebuild process. If you continue to use the CLONE volume during the rebuild, the rebuild process will take a longer time to complete, and the host data transfer performance will also be affected.

It is also possible to create a CLONE volume using one hard disk drive connected to Port 1 of the *TowerRAID TR5UT(-B)*, although no clone will occur until a second hard disk drive is connected to Port 1. With only one hard disk drive connected, the CLONE volume will be available, although no data protection will be provided until a second hard disk drive is connected.

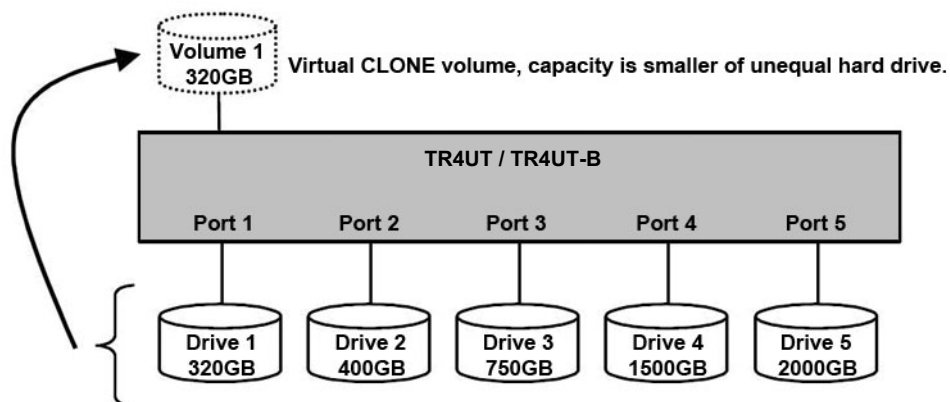

**Figure: CLONE MODE storage policy sample configuration.**

## 2.4 R0 MODE

The R0 MODE storage policy distributes access across all hard disks. R0 MODE presents the best data speed but no data redundancy. R0 MODE storage policy accelerates hard disk drive operating speed by using many disks in parallel. Hard disk drive data segments are written to different disks simultaneously which increases performance while sacrificing data redundancy.

To implement the R0 MODE storage policy, the TowerRAID TR5UT/TR5UT-B storage creates a single virtual volume that is striped across both hard drives, with a storage capacity that is five times of the smallest drive.

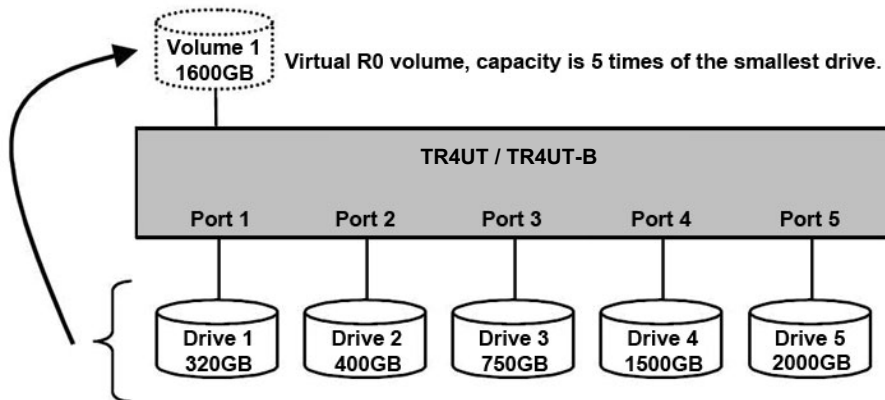

Figure: R0 MODE storage policy sample configuration.

## 2.5 RI MODE

The RI MODE storage policy stores all data in duplicate on separate drives to protect against data loss due to drive failure. One drive *mirrors* the other at all times. Every write operation goes to both drives. RI MODE provides the highest level of data protection for critical data that you cannot afford to lose if a hard drive fails, but halves the amount of storage capacity because all data must be stored twice. The resulting storage capacity of the virtual RI volume will be equivalent to the size of one hard drive (if both drives are the same) or the smaller of the two drives (if they are different).

If one drive fails, the RI volume is still usable, but it is in a vulnerable state because its mirrored hard drive is inaccessible. When the offline drive comes back online, the appliance begins a rebuild process immediately to restore data redundancy. A message appears in the LED indicator to notify you that a rebuild is in progress.

Although the volume remains available during the rebuild process, the volume is susceptible to data loss through damage to the remaining drive until redundancy is restored at the end of the rebuild and verification process. Host access takes precedence over the rebuild process. If you continue to use the RI volume during the rebuild, the rebuild process will take a longer time to complete, and the host data transfer performance will also be affected.

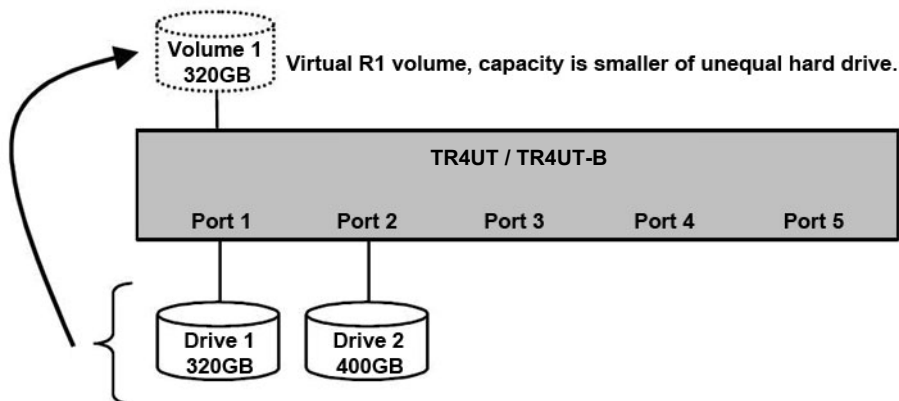

Figure: R1 MODE storage policy sample configuration.

## 2.6 R10 MODE

The R10 MODE storage policy combines the features of both R0 and R1. Performance is provided through the use of R0 MODE, while adding the fault tolerance of R1. The implementation of R10 requires four drives. The drives are assigned as two sets of striped pairs. The data is written to R1 set and provides data redundancy. Alternating blocks of data are then striped (R0) across another R1 set. This provides improved speed. The resulting storage capacity of the virtual R10 volume will be two times of the smallest drive.

If one drive fails, the R10 volume is still usable, but it is in a vulnerable state because its mirrored hard drive is inaccessible. When the offline drive comes back online, the appliance begins a rebuild process immediately to restore data redundancy. A message appears in the LED indicator to notify you that a rebuild is in progress.

Although the volume remains available during the rebuild process, the volume is susceptible to data loss through damage to the remaining drive until redundancy is restored at the end of the rebuild and verification process. Host access takes precedence over the rebuild process. If you continue to use the R10 volume during the rebuild, the rebuild process will take a longer time to complete, and the host data transfer performance will also be affected.

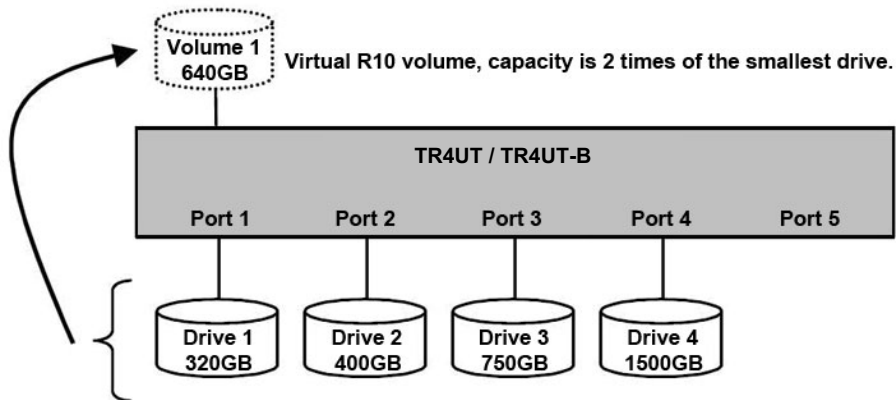
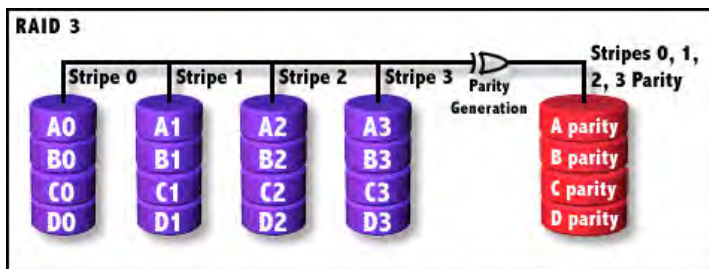

Figure: R10 MODE storage policy sample configuration.

## 2.7 R3 MODE

The R3 MODE storage policy requires a minimum of 3 drives to implement. The R3 MODE adds fault tolerance to drive striping by including parity information with the data. R3 MODE dedicates the equivalent of one drive for storing parity stripes. The data and parity information is arranged on the drive array so that parity is written to one drive. There are at least 3 members to a virtual R3 volume. The following example illustrates how the parity is rotated from drive to drive.



The R3 MODE uses less capacity for protection and is the preferred method to reduce the cost per megabyte for larger installations.

In exchange for low overhead necessary to implement protection, the R3 MODE degrades performance for all write operations. The parity calculations for R3 MODE may result in write performance that is somewhat slower than the write performance to a single drive.

The resulting storage capacity of the virtual R3 volume will be four times of the smallest drive.

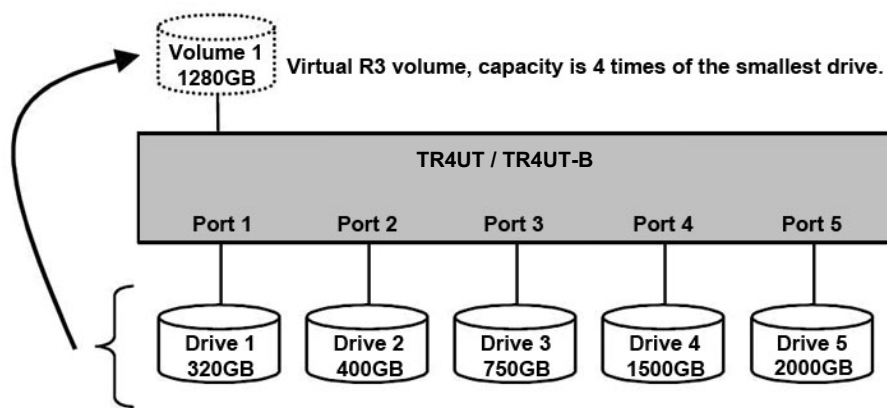
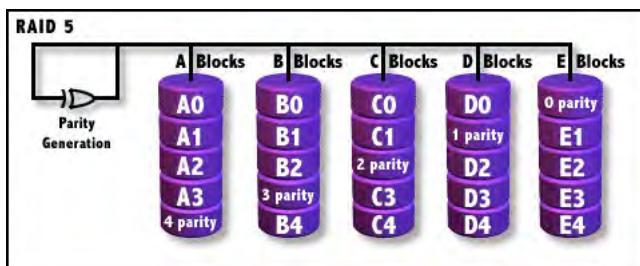

**Figure: R3 MODE storage policy sample configuration.**

If one drive fails, the virtual R3 volume is still usable, but it is in a vulnerable state because its mirrored hard drive is inaccessible. When the offline drive comes back online, the appliance begins a rebuild process immediately to restore data redundancy. A message appears in the LED indicator to notify you that a rebuild is in progress. Although the volume remains available during the rebuild process, the volume is susceptible to data loss through damage to the remaining drive until redundancy is restored at the end of the rebuild and verification process. Host access takes precedence over the rebuild process. If you continue to use the virtual R3 volume during the rebuild, the rebuild process will take a longer time to complete, and the host data transfer performance will also be affected.

## 2.8 R5 MODE

The R5 MODE storage policy requires a minimum of 3 drives to implement. The R5 MODE adds fault tolerance to drive striping by including parity information with the data. R5 MODE dedicates the equivalent of one drive for storing parity stripes. The data and parity information is arranged on the drive array so that parity is written to all drives. There are at least 3 members to a virtual R5 volume. The following example illustrates how the parity is rotated from drive to drive.



The R5 MODE uses less capacity for protection and is the preferred method to reduce the cost per megabyte for larger installations.

In exchange for low overhead necessary to implement protection, the R5 MODE degrades performance for all write operations. The parity calculations for R5 MODE may result in write performance that is somewhat slower than the write performance to a single drive.

The resulting storage capacity of the virtual R5 volume will be four times of the smallest drive.

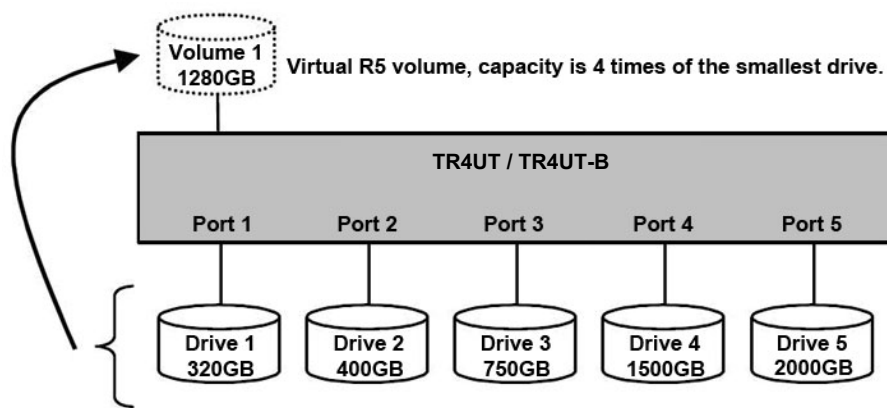

**Figure: R5 MODE storage policy sample configuration.**

If one drive fails, the virtual R5 volume is still usable, but it is in a vulnerable state because its mirrored hard drive is inaccessible. When the offline drive comes back online, the appliance begins a rebuild process immediately to restore data redundancy. A message appears in the LED indicator to notify you that a rebuild is in progress. Although the volume remains available during the rebuild process, the volume is susceptible to data loss through damage to the remaining drive until redundancy is restored at the end of the rebuild and verification process. Host access takes precedence over the rebuild process. If you continue to use the virtual R5 volume during the rebuild, the rebuild process will take a longer time to complete, and the host data transfer performance will also be affected.

---

# 3 INSTALLATION

## 3.1 INSTALLING HARD DISK DRIVE

Please refer below procedure to complete the HDD installation.

- Open the drive door than unlock the HDD tray lock to remove the HDD trays from TERA STOR SATA RAID III.

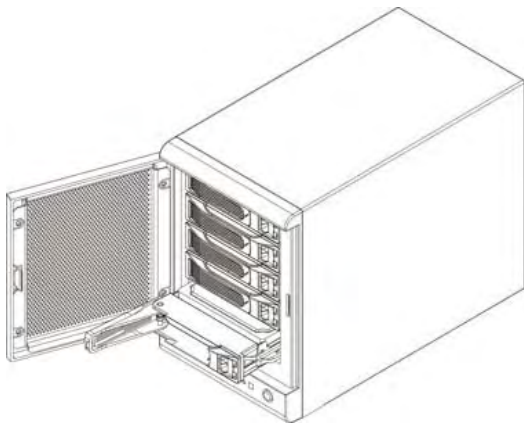

- Install the HDD into the HDD tray.

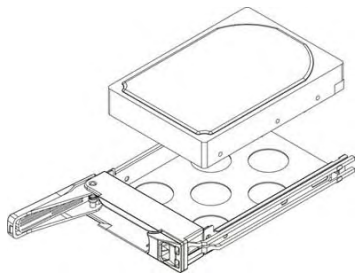

- Twist the HDD screws shut to seat the drive securely.

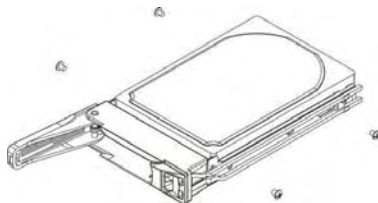

- Insert the HDD tray back to the TowerRAID TR5UT(-B).

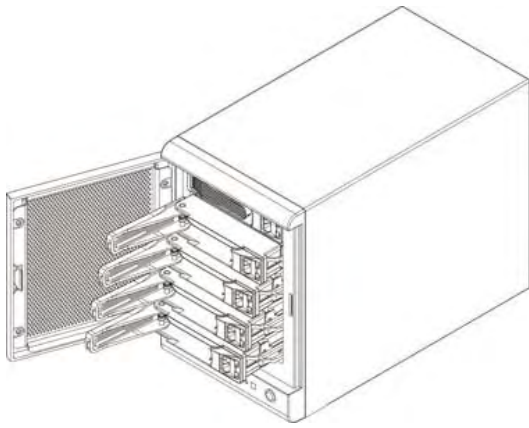

- Close the drive door to complete hard drive disk installation.

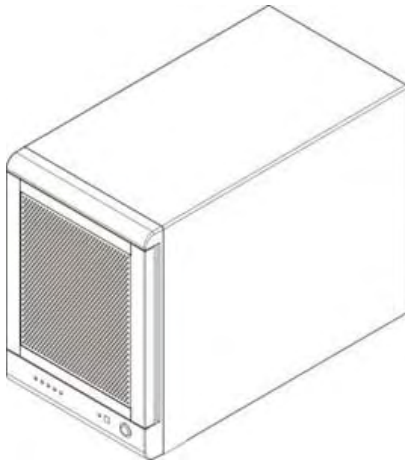

## 3.2 POWER ON / OFF

- Push the power button to power on, and push again to power off.

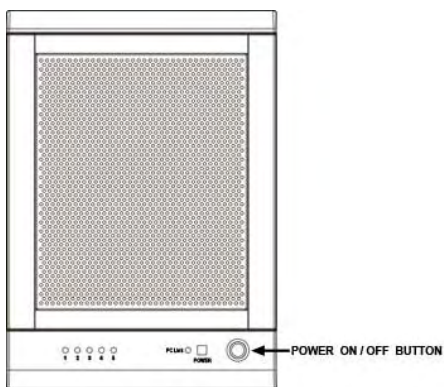

---

### 3.3 INSTALLING SATA TO ESATA BRACKET CABLE

- Remove a free I/O bracket from your computer.

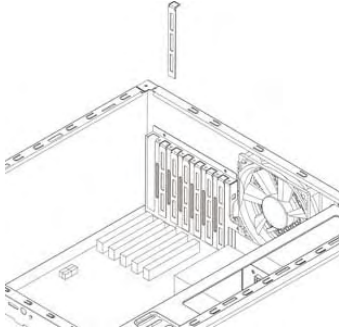

- Install the SATA TO ESATA BRACKET CABLE to the free I/O bracket, and connect the SATA cable to a free SATA port from your computer.

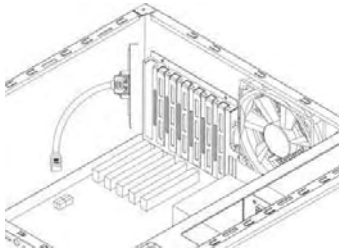

### 3.4 INSTALLING HOST BUS ADAPTER

The package is bundled with Highpoint R622 controller card. The controller card does not require driver installation except Windows 2000/XP/2003. Please review Highpoint R6XX Quick Installation Guide for details.

---

# 4 CONFIGURATION

## 4.1 CONFIGURATION PREREQUISITES

### 4.1.1 SATA HOST CONNECTIONS

This guide assumes that you have already attached the *TowerRAID TR5UT/TR5UT-B* to a host computer that has been installed with the R622 HBA (Host Bridge Adapter) or another SATA HBA with Port Multiplier (PM) support. If you use a host controller that does not provide Port Multiplier support (Such as R622 or Intel ICH):

- The CLEAN MODE storage policy is unavailable when configuring the *TowerRAID TR5UT(-B)*. Only one disk is available on the host computer.
- Virtual volumes that you create in the Advanced Configuration Wizard must use at least 8 gigabytes (GB) of available system capacity.

### 4.1.2 USB HOST CONNECTIONS

If you are connecting your *TowerRAID TR5UT/TR5UT-B* using a USB connection to your host, the USB port should be compliant with USB 1.0, 2.0 or connected to a USB hub.

## 4.2 CHANGING HOST CONNECTIONS

The *TOWERRAID TR5UT/TR5UT-B* supports both USB and eSATA host connections, although only one connection can be attached at any given time. For the best data transfer performance, you should always use the eSATA host connection. If it becomes necessary to change the host connection between eSATA and USB, the host computer system and the *TowerRAID TR5UT/TR5UT-B* should both be powered down prior to making the host connection change to avoid any potential data loss or corruption. After changing the host connection, all items can be powered-up to resume operation with the new host connection.

## 4.3 DISCONNECTING A USB DEVICE

USB 2.0 external devices provide support for “plug & play” connection, so that your USB storage device can be connected and disconnected while the computer is running. To prevent data loss or other failures, you must follow these steps when disconnecting your USB 2.0 storage device from your host computer system. Once the physical USB device is disconnected, any volumes that are associated with that device will become unavailable. On O/S (Operation Systems), the *TowerRAID TR5UT/TR5UT-B* must be stopped from O/S before any devices can be disconnected.

### 4.3.1 WINDOWS SYSTEMS

1. Click on the Eject icon (a small green arrow over a hardware image) in the System Tray located in the lower right-hand side of your screen.



2. A message will appear listing all of the devices that the Eject icon controls. Click on the “Safely remove USB Mass Storage Device” item.
3. The following message then appears: “Safe to Remove Hardware”. You can now safely disconnect the device from your computer.

**Note:** If your host USB adapter does not support this feature, the device should be disabled using the Device Manager or your system should be shut down cleanly and powered off before disconnecting the USB device.

### 4.3.2 MACINTOSH SYSTEMS

You must un-mount the hard disk drive by dragging the hard drive icon to the trash before disconnecting it or powering it down.

## 4.4 HARD DISK DRIVE HOT-PLUG & HOT-UNPLUG

The hard disk drives should not be hot-plugged, unless RAID failure occurs. To avoid data corruption or loss, care should be taken to ensure that the host system is not currently using any drive that is about to be hot-unplugged.

## 4.5 LED INDICATIVE STATUS

TowerRAID TR5UT/TR5UT-B provides information on the SATA HDDs, PC Link, and Power LEDs.

Each LED activity will turn On/Off the LED for approximately 70 ms. The blinking rate is approximately 400 ms On and 400 ms Off.

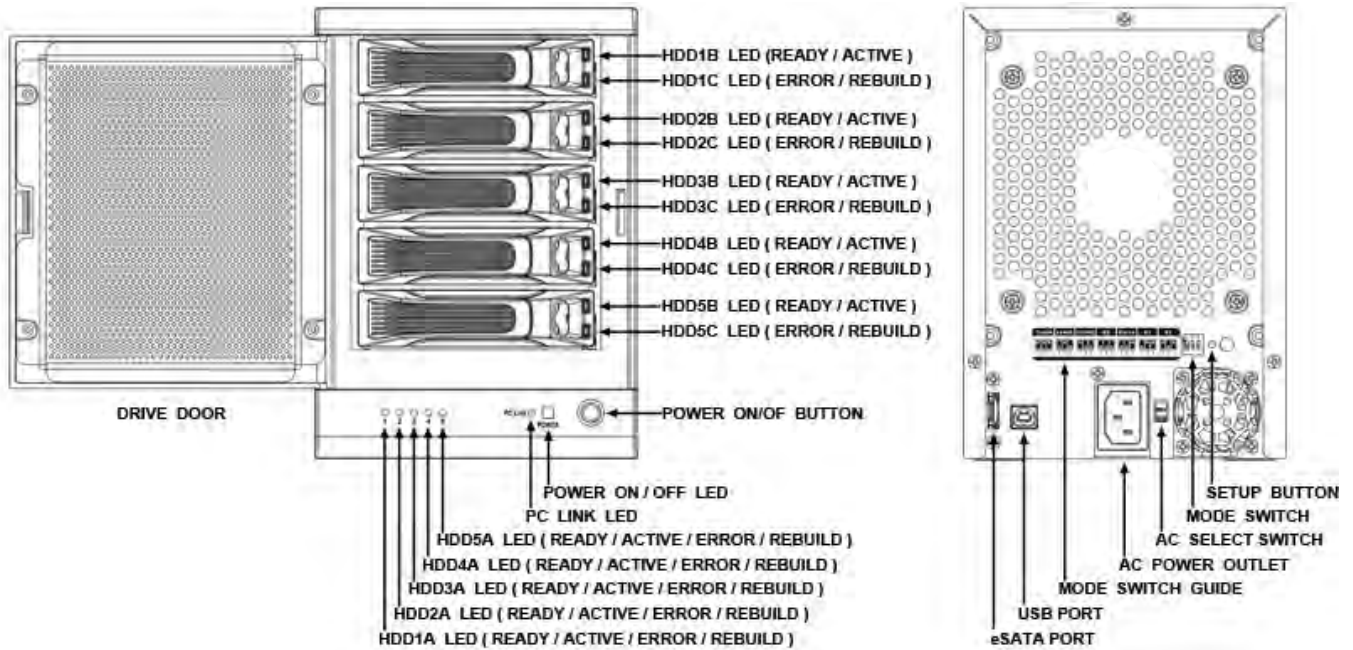

### 4.5.1 POWER LED

The TowerRAID TR5UT/TR5UT-B has one Amber color Power LED. The table shows Power LED function and operation.

DESCRIPTION	GREEN LED
Power On	On
Power Off	Off

### 4.5.2 PC LINK LED

The TowerRAID TR5UT/TR5UT-B has one Green color PC Host Link LED. The table shows PC Link LED function and operation.

DESCRIPTION	GREEN LED
PC Link Unplugged / No Power	Off
PC Link plugged	On

### 4.5.3 HARD DISK DRIVE LED

The TowerRAID TR5UT/TR5UT-B has five HDD LEDs (Green and Red) on the front panel and ten green LED on the HDD tray (two on each tray). The table shows HDD LED function and operation. These LEDs behave as follows:

#### 4.5.3.1 THE FRONT PANEL LED

DESCRIPTION	GREEN LED	RED LED
HDD Unplugged / No Power	Off	Off
HDD plugged (Idle)	On	Off
HDD plugged (Active)	Blink (On)	Off
Error State (One or More Bad Partial Volumes)	Off	On
HDD Rebuild (A Physical Partition is being Rebuild; i.e. Mirroring Mode)	Off	Blink (On)

### 4.5.3.2 THE HDD TRAY LED

DESCRIPTION	GREEN (UPPER)	GREEN (LOWER)
HDD Unplugged / No Power	Off	Off
HDD plugged (Idle)	On	Off
HDD plugged (Active)	Blink (On)	Off
Error State (One or More Bad Partial Volumes)	Off	On
HDD Rebuild (A Physical Partition is being Rebuild; i.e. Mirroring Mode)	On	Blink (On)

## 4.6 MODE SETTING

The TowerRAID TR5UT/TR5UT-B with the device's LEDs to indicate status. To select a storage policy in this mode the first time that a new factory-shipped product is used, ensure that the hard disk drives are installed; turn off the power before set the MODE SWITCH on the back of the TowerRAID TR5UT/TR5UT-B to the desired Storage Policy. To change the storage policy thereafter, set the MODE SWITCH to the desired position and press and hold the recessed SETUP BUTTON, than power on to create the new virtual volume(s). Creating new virtual volumes will destroy any existing data that existed on the previous volume.

**Note: Before reconfiguring a volume, back up your data and delete previously defined partitions.**

### 4.6.1 CLEAN MODE

The CLEAN MODE storage policy requires a minimum of 1 drive to implement.  
 1. Turn off the power.

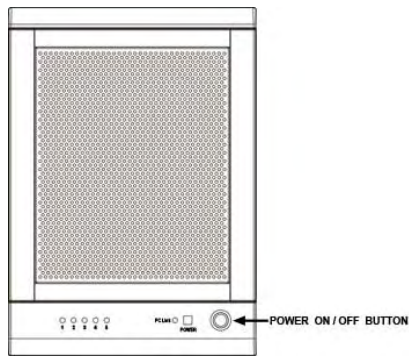

2. Set the MODE SWITCH position to CLEAN.

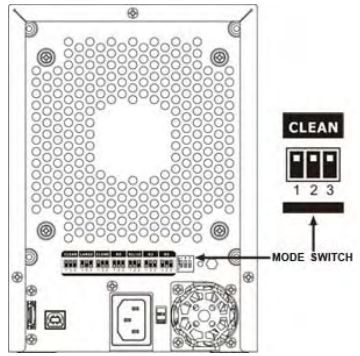

3. Press and hold the recessed SETUP BUTTON.

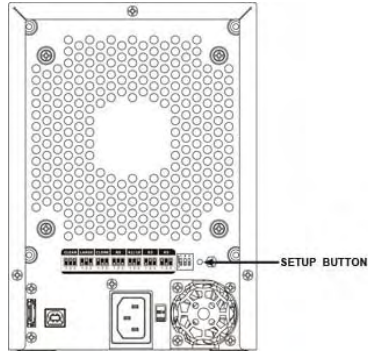

4. Turn on the power than release the SETUP BUTTON to complete mode setting.

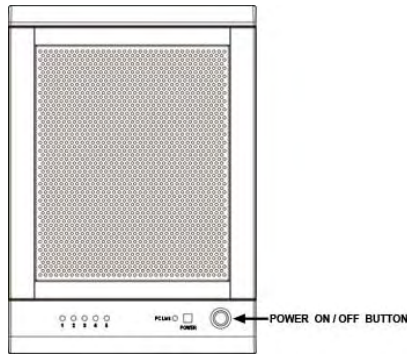

#### 4.6.2 LARGE MODE

The LARGE MODE storage policy requires a minimum of 2 drives to implement.

1. Turn off the power.

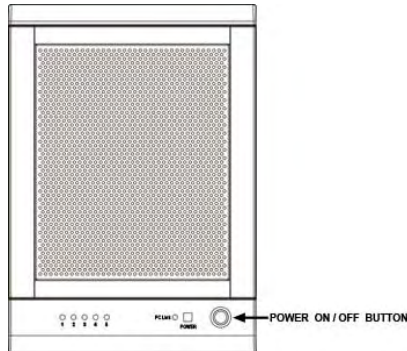

2. Set the MODE SWITCH position to LARGE.

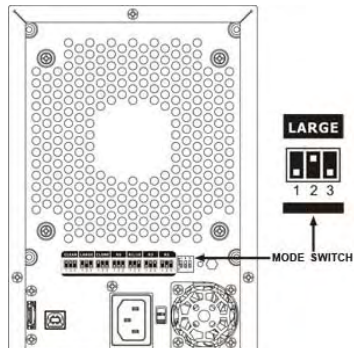

---

3. Press and hold the recessed SETUP BUTTON.

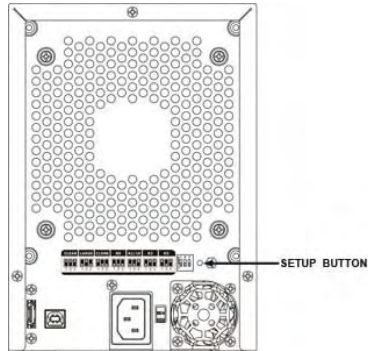

4. Turn on the power than release the SETUP BUTTON to complete mode setting.

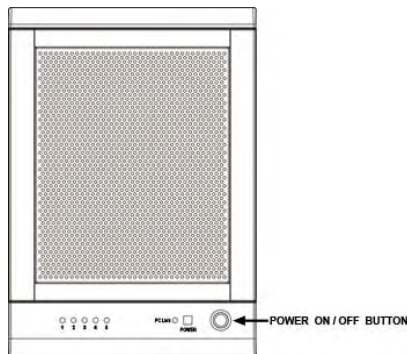

#### 4.6.3 CLONE MODE

The CLONE MODE storage policy requires a minimum of 2 drives to implement.

1. Turn off the power.

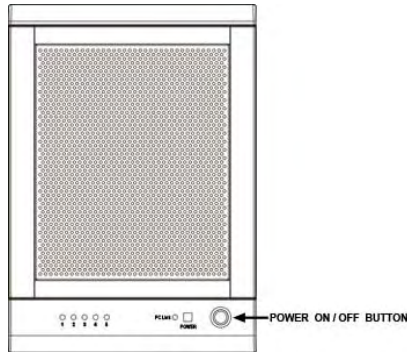

2. Set the MODE SWITCH position to CLONE.

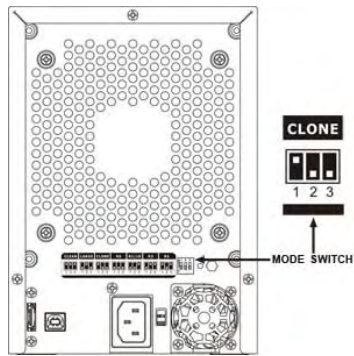

3. Press and hold the recessed SETUP BUTTON.

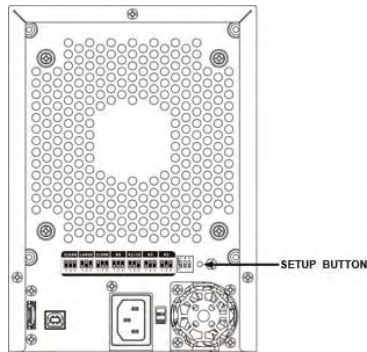

4. Turn on the power than release the SETUP BUTTON to complete mode setting.

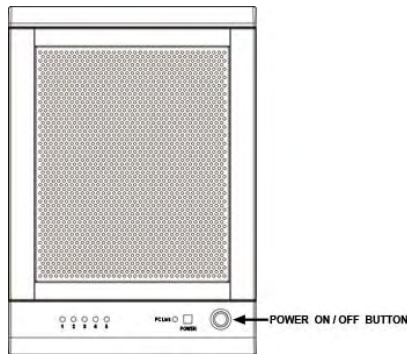

#### 4.6.4 CLONE MODE WITH HOT SPARE

The CLONE MODE storage policy with hotspare drive requires a minimum of 3 drives to implement.

1. Turn off the power.

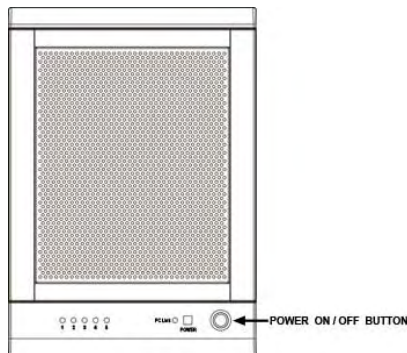

2. Insert 2 drives in order from the top to the bottom.

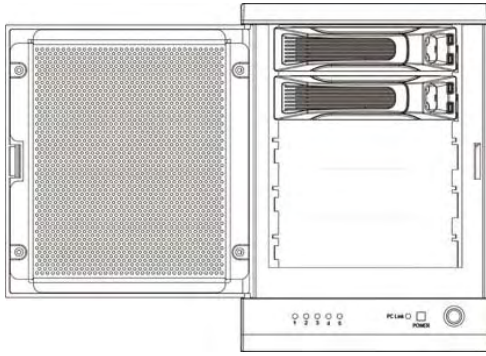

3. Set the MODE SWITCH position to CLONE.

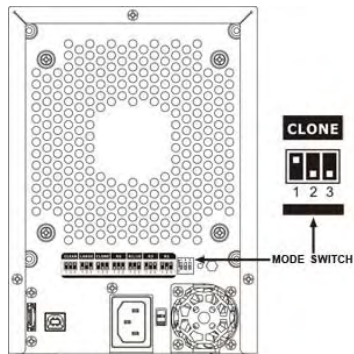

4. Press and hold the recessed SETUP BUTTON.

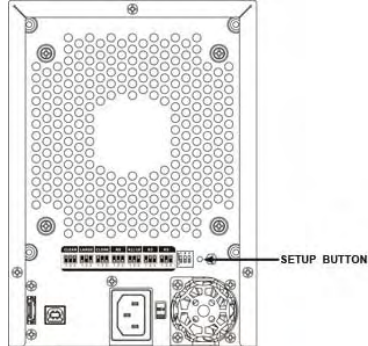

5. Turn on the power than release the SETUP BUTTON.

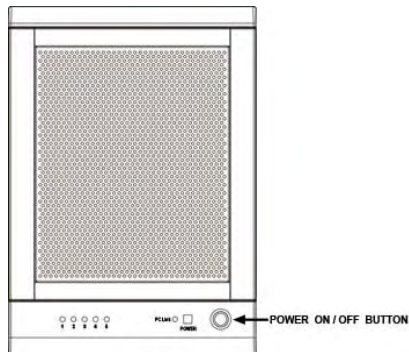

6. Turn off the power.

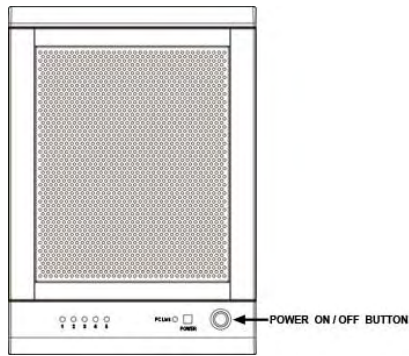

7. Insert the hotspare drive into the 3<sup>rd</sup> HDD bay.

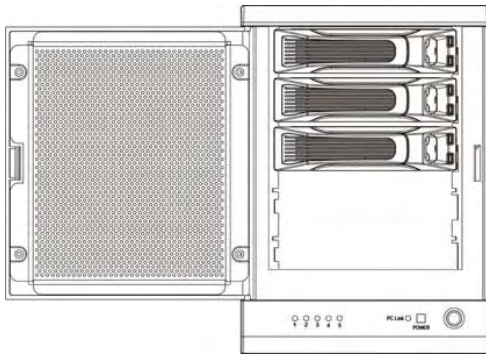

8. Turn on the power to complete mode setting.

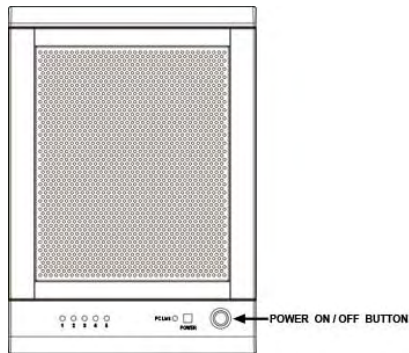

#### 4.6.5 R0 MODE

The R0 MODE storage policy requires a minimum of 2 drives to implement.

1. Turn off the power.

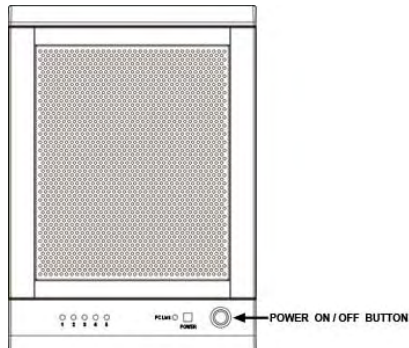

2. Set the MODE SWITCH position to R0.

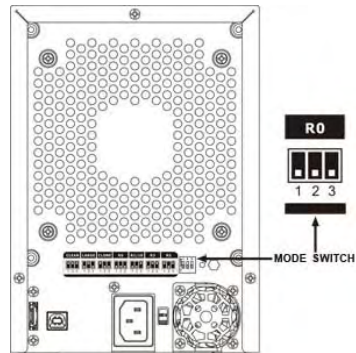

3. Press and hold the recessed SETUP BUTTON.

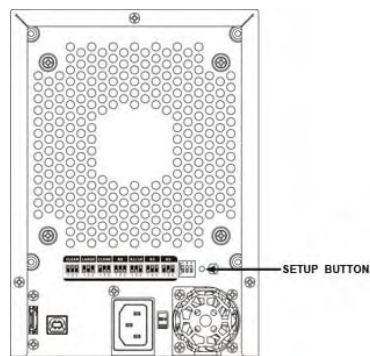

4. Turn on the power than release the SETUP BUTTON to complete mode setting.

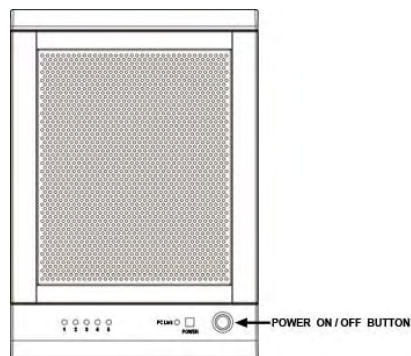

#### 4.6.6 RI MODE

The RI MODE storage policy requires 2 drives to implement.

1. Turn off the power.

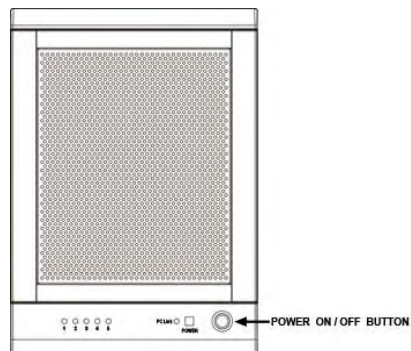

2. Set the MODE SWITCH position to R1/R10.

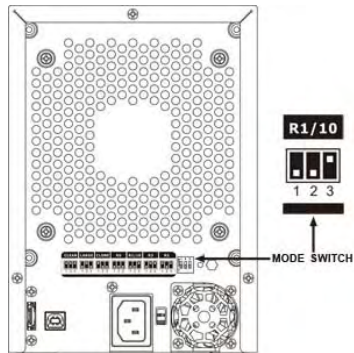

3. Press and hold the recessed SETUP BUTTON.

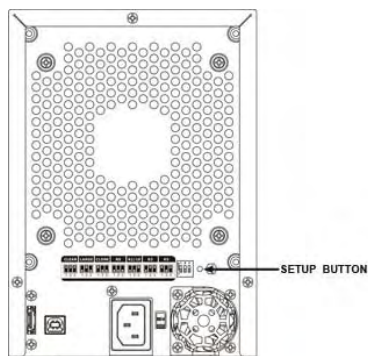

4. Turn on the power than release the SETUP BUTTON to complete mode setting.

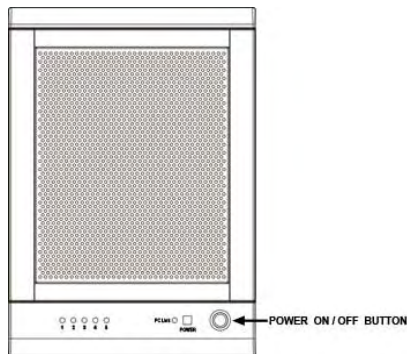

#### 4.6.7 RI MODE WITH HOT SPARE

1. Turn off the power.

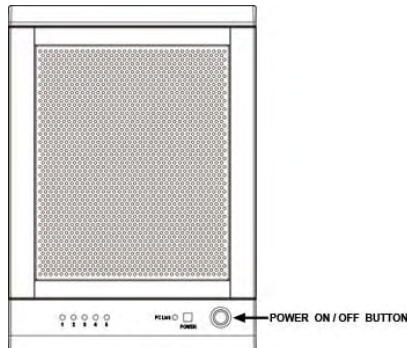

2. Insert 3 drives in order from the top to the bottom.

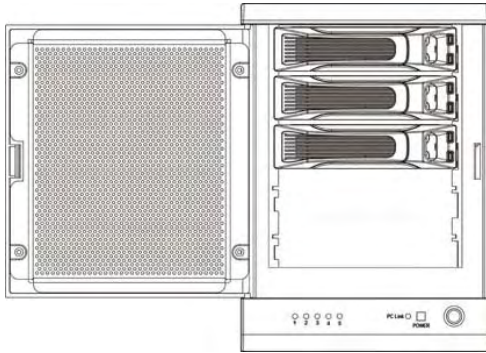

3. Set the MODE SWITCH position to R1/R10.

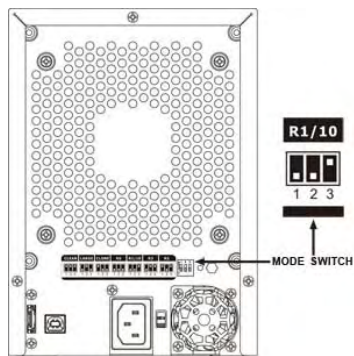

4. Press and hold the recessed SETUP BUTTON.

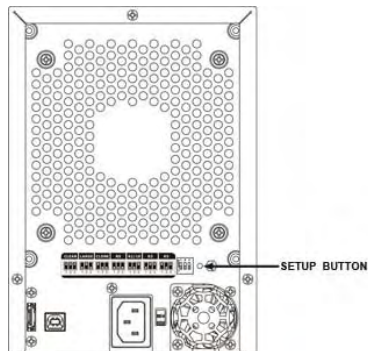

5. Turn on the power than release the SETUP BUTTON to complete mode setting.

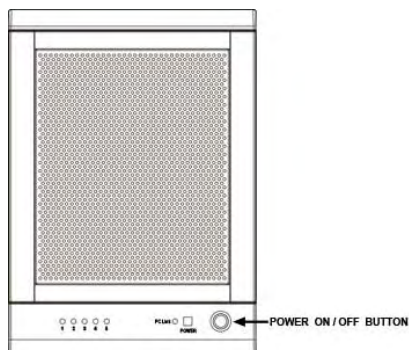

#### 4.6.8 R10 MODE

The R10 MODE storage policy requires 4 drives to implement.

1. Turn off the power.

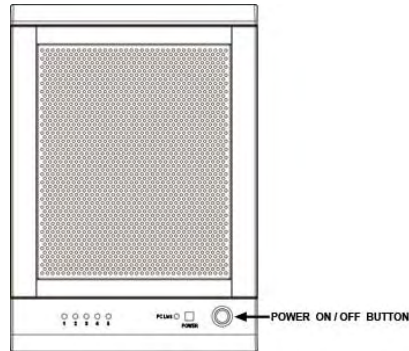

2. Set the MODE SWITCH position to R1/R10.

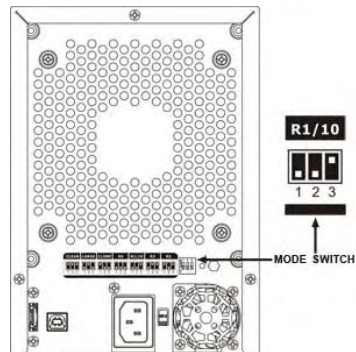

3. Press and hold the recessed SETUP BUTTON.

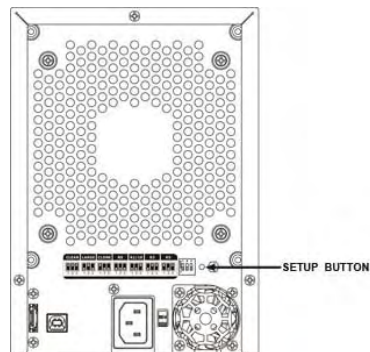

4. Turn on the power than release the SETUP BUTTON to complete mode setting.

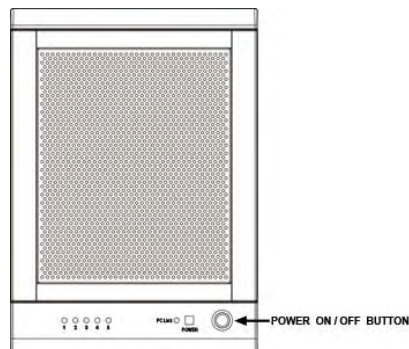

#### 4.6.9 R10 MODE WITH HOT SPARE

1. Turn off the power.

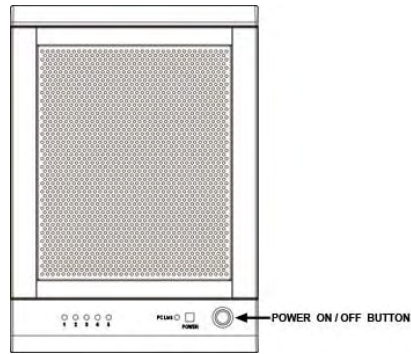

2. Insert 5 drives in order from the top to the bottom.

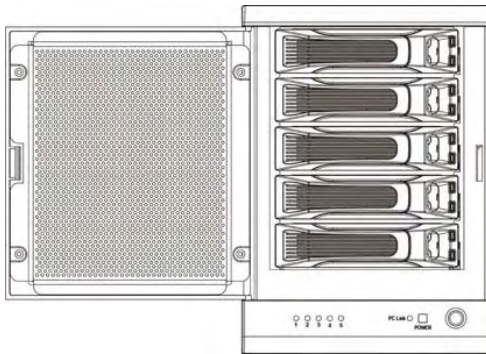

3. Set the MODE SWITCH position to R1/R10.

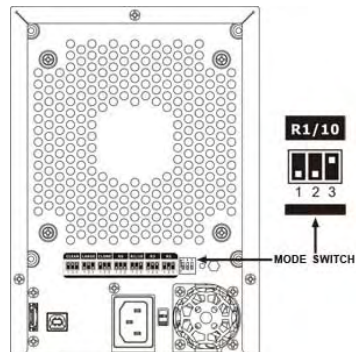

4. Press and hold the recessed SETUP BUTTON.

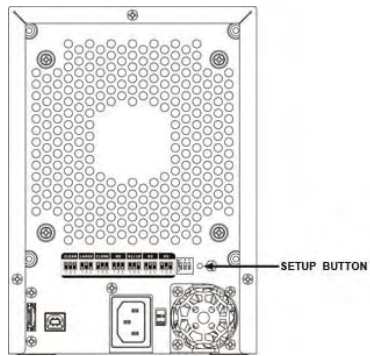

5. Turn on the power than release the SETUP BUTTON to complete mode setting.

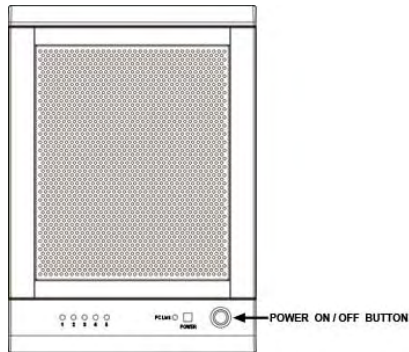

#### 4.6.10 R3 MODE

The R3 MODE storage policy requires a minimum of 3 drives to implement.

1. Turn off the power.

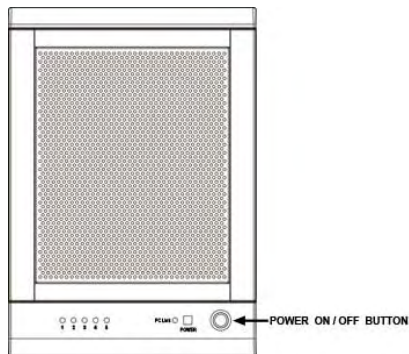

2. Set the MODE SWITCH position to R3.

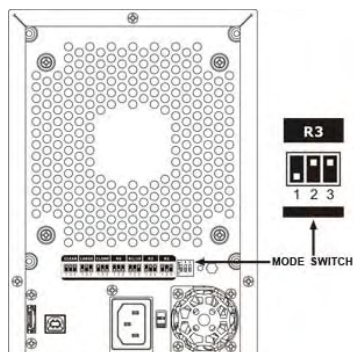

3. Press and hold the recessed SETUP BUTTON.

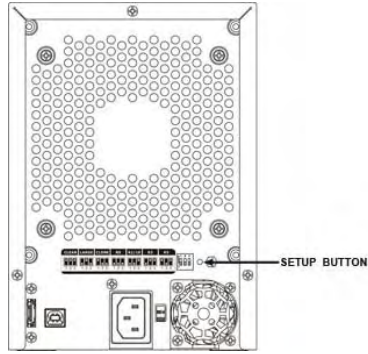

4. Turn on the power than release the SETUP BUTTON to complete mode setting.

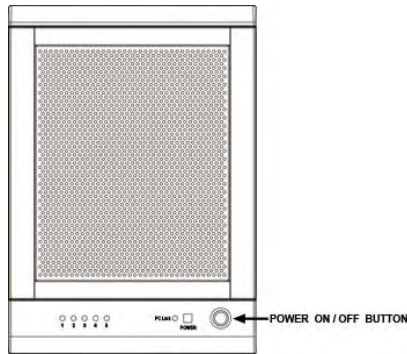

#### 4.6.11 R3 MODE WITH HOT SPARE

The R3 MODE storage policy with hot spare drive requires a minimum of 4 drives to implement.

1. Turn off the power.

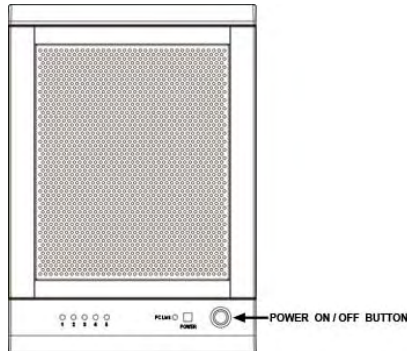

2. Insert 3 drives in order from the top to the bottom.

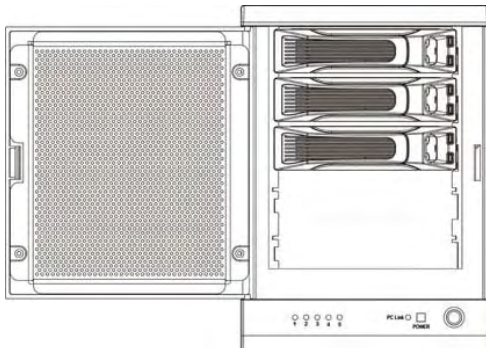

3. Set the MODE SWITCH position to R3.

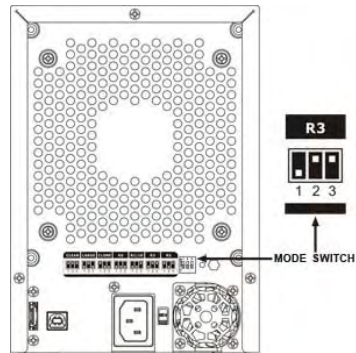

4. Press and hold the recessed SETUP BUTTON.

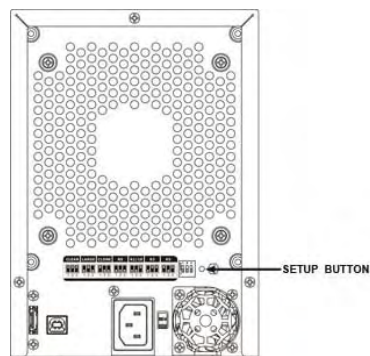

5. Turn on the power than release the SETUP BUTTON.

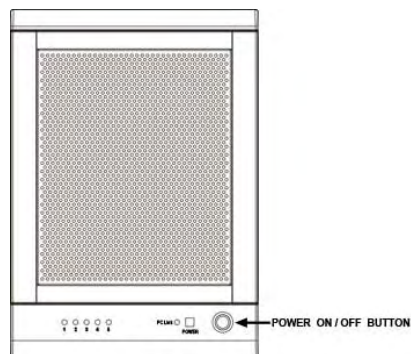

6. Turn off the power.

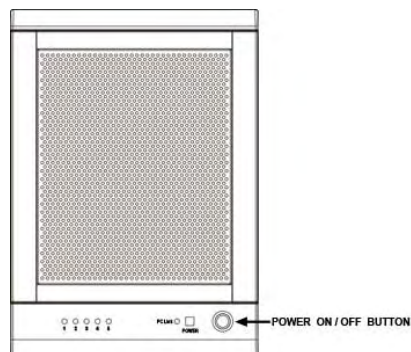

---

7. Insert the hotspare drive into the 4<sup>th</sup> HDD bay.

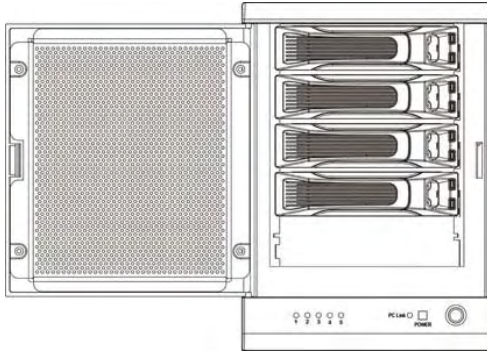

8. Turn on the power to complete mode setting.

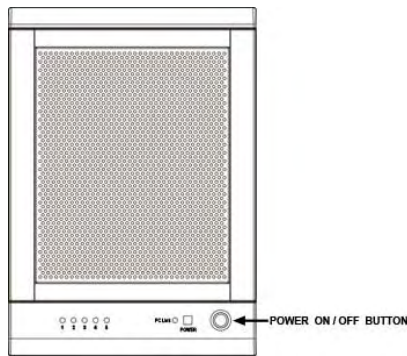

#### 4.6.12 R5 MODE

The R5 MODE storage policy requires a minimum of 3 drives to implement.

1. Turn off the power.

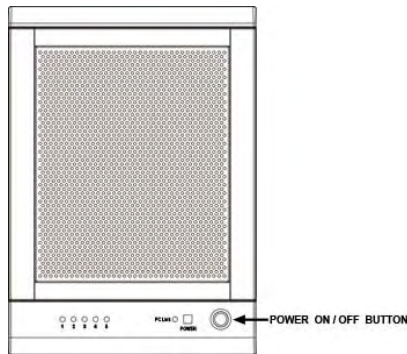

2. Set the MODE SWITCH position to R5.

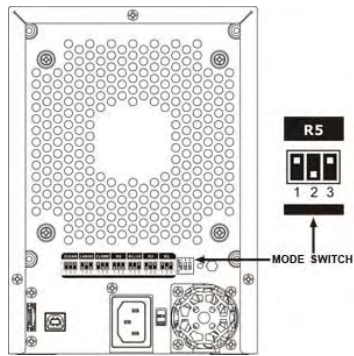

3. Press and hold the recessed SETUP BUTTON.

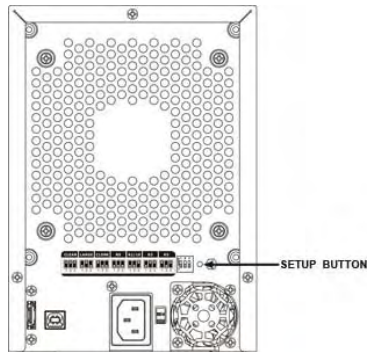

4. Turn on the power than release the SETUP BUTTON to complete mode setting.

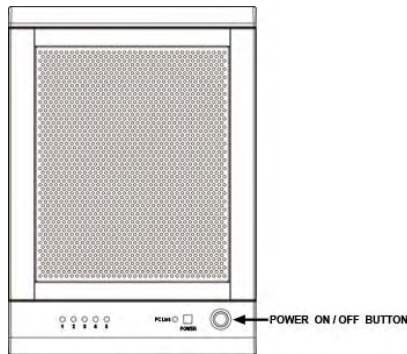

#### 4.6.13 R5 MODE WITH HOT SPARE

The R5 MODE storage policy with hot spare drive requires a minimum of 4 drives to implement.

1. Turn off the power.

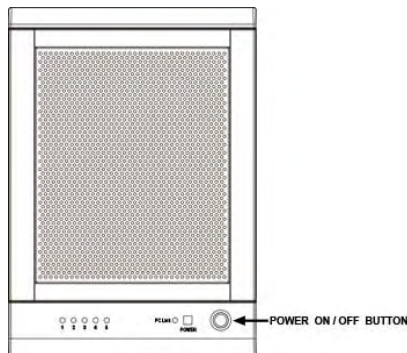

2. Insert 3 drives in order from the top to the bottom.

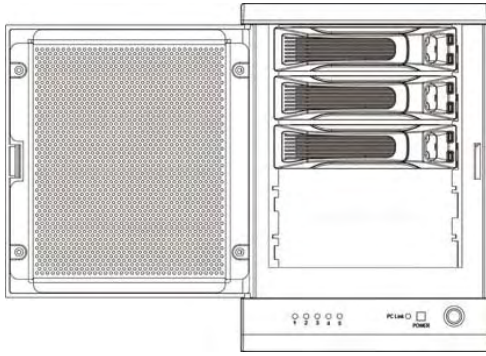

3. Set the MODE SWITCH position to R5.

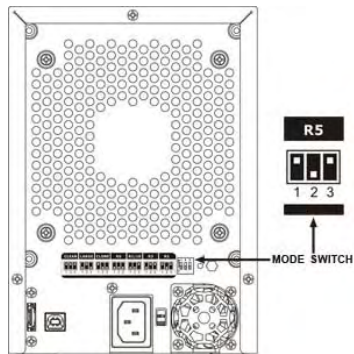

4. Press and hold the recessed SETUP BUTTON.

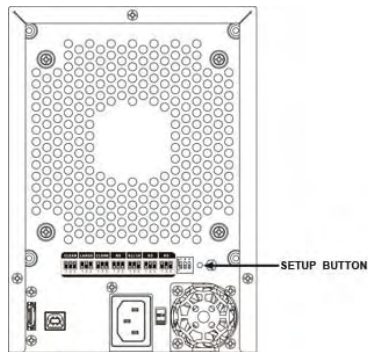

5. Turn on the power than release the SETUP BUTTON.

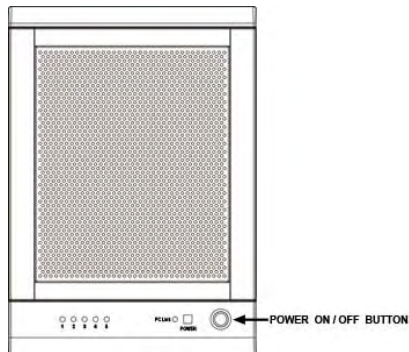

6. Turn off the power.

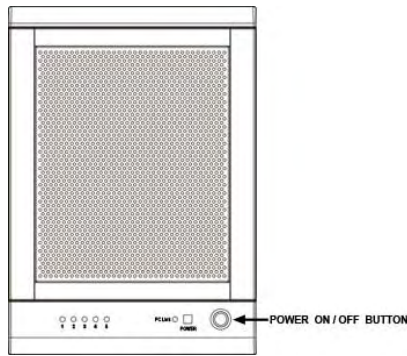

7. Insert the hot spare drive into the 4<sup>th</sup> HDD bay.

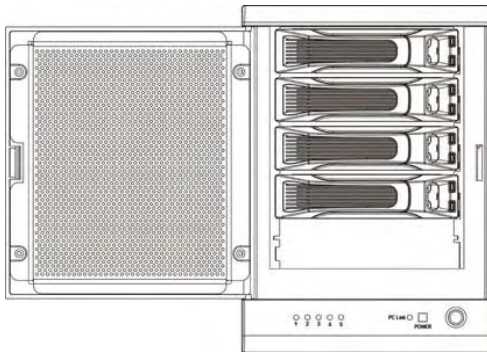

8. Turn on the power to complete mode setting.

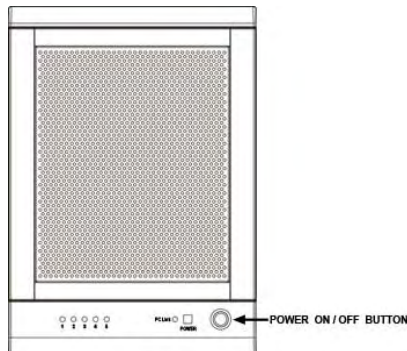

## 4.7 REBUILDING A REDUNDANCY OR HOT SPARE DRIVE

The *TOWERRAID TR5UT/TR5UT-B* storage appliance stores all data in duplicate on separate drives to protect against data loss due to drive failure on CLONE, R1, R3, R5, and R10 MODE. The following example illustrates how the procedure to rebuilding a redundancy or hot spare drive.

### 4.7.1 REBUILDING A REDUNDANCY DRIVE

1. If the drive 2 has breakdown, please remove the breakdown drive 2.

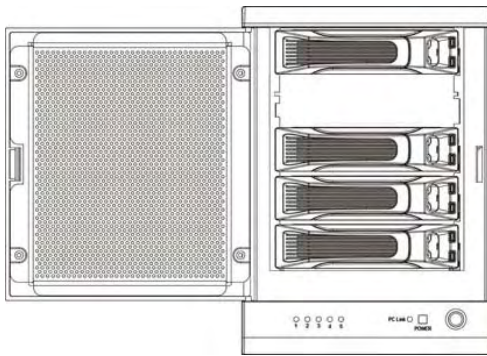

2. Turn off the power.

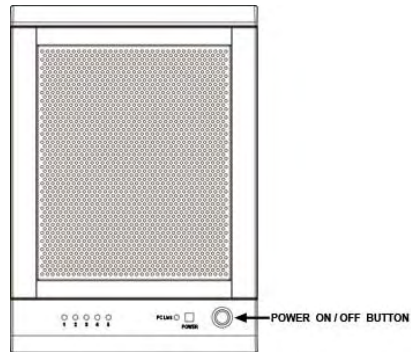

3. Replace a same or larger size of hard disk drive.

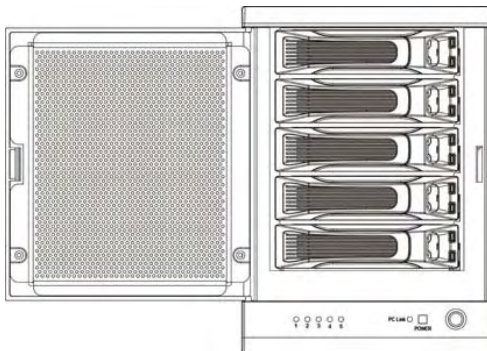

4. Turn on the power.

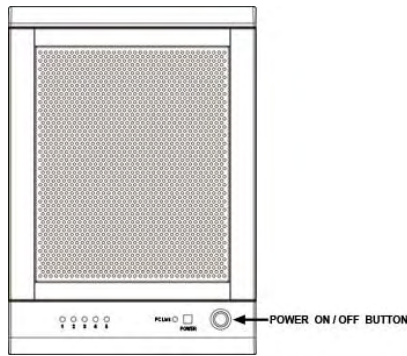

5. The *TOWERRAID TR5UT/TR5UT-B* storage appliance will rebuild the virtual volume from degrade mode to normal automatically (Approximately 200GB/hour).

#### 4.7.2 REBUILDING A HOT SPARE DRIVE

1. If there is a hot spare drive on drive 5, and the drive 2 has breakdown, the hot spare drive on drive 5 will replace the breakdown drive and rebuild automatically. To setup a new hot spare drive, please remove the breakdown drive 2.

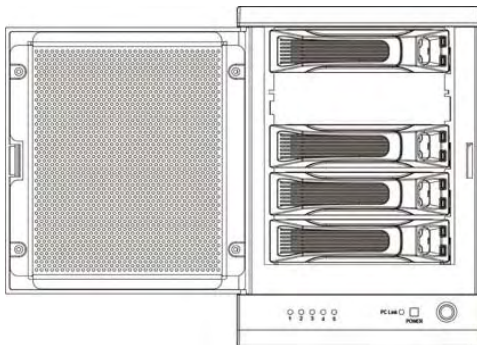

2. Turn off the power.

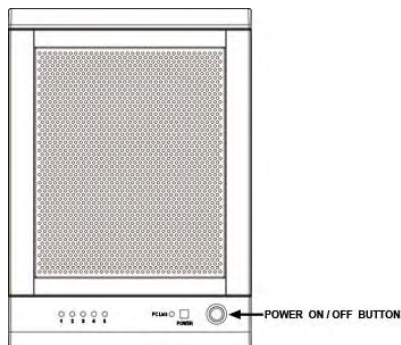

---

3. Replace a same or larger size hard disk drive.

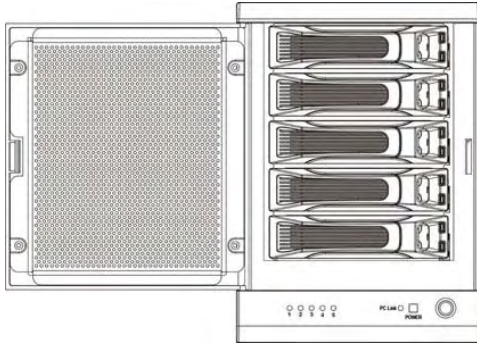

4. Turn on the power.

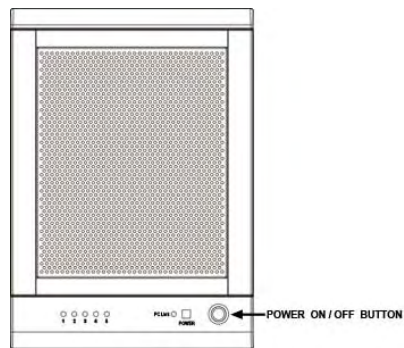

5. The *TOWERRAID TR5UT/TR5UT-B* storage appliance will replace a hot spare drive on drive 2 automatically.

---

# 5 PARTITIONING VOLUMES

## 5.1 PARTITION A VOLUME

### 5.1.1 WINDOWS SYSTEMS

**Note:** Before repartition a volume, back up your data and delete previously defined partitions.

1. Right-click the **My Computer** icon on your desktop and select **Manage** from the pop-up window.

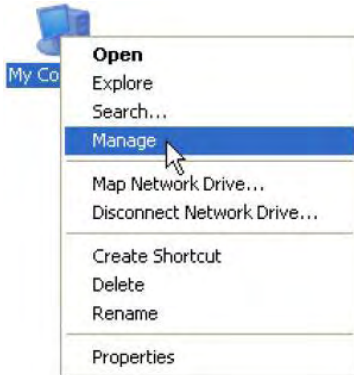

2. Select **Disk Management** under **Storage** to open the Windows Disk Manager. This example illustrates the **LARGE** storage policy, which concatenates the capacity of all hard drives connected to the *TERA STOR SATA RAID III*.

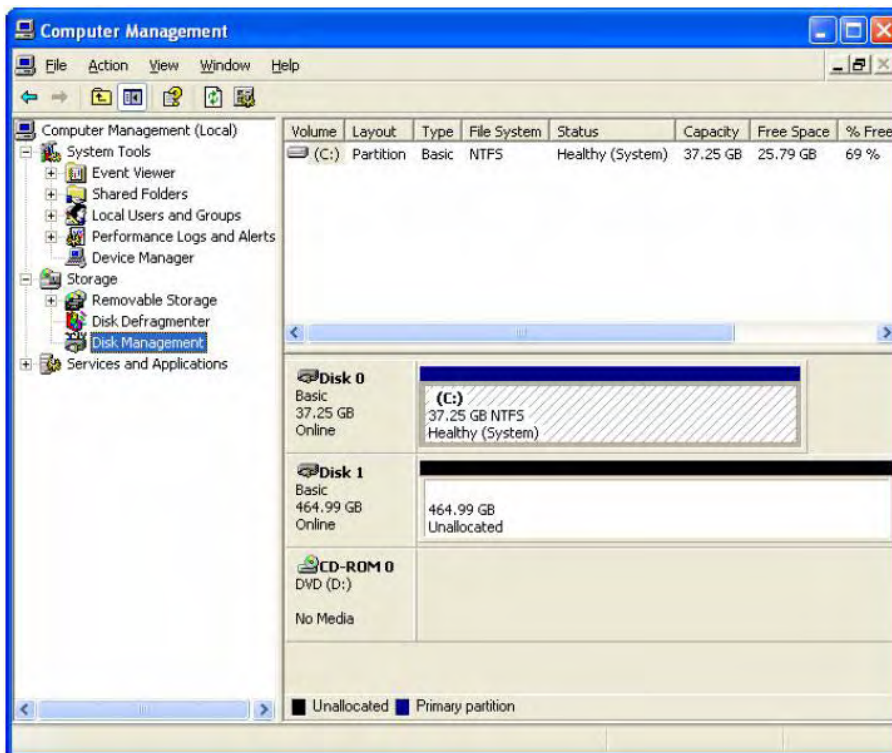

Every disk should appear with the word “**Basic**”, a size value that shows the available storage capacity, and a status of “**Online**”. Instead of **Basic**, a disk could appear **Unknown**, **Dynamic**, or **Not Initialized**.

If the disk appears as “**Unknown**”, right-click the disk icon and select **Write Signature**. A window opens with the selected disk (all Unknown disks may appear in this window). Make sure the box next to each disk is checked and click **OK**. The disk should now be marked as a **Basic** disk.

If a disk appears as “**Dynamic**”, right-click the disk icon, and select **Revert to Basic Disk**. Within a few

seconds, the disk should be marked as a **Basic** disk.

If a disk is marked “**Not Initialized**”, right-click the disk icon and select **Initialize Disk**. An additional dialog box appears allowing you to select which disks to initialize. Uncheck the SteelVine Processor Disk item and click **OK**. Within a few seconds, the selected disk(s) should be marked as a **Basic** disk.

**Note:** Be sure that you select the correct disk based on the expected disk capacity to create a partition.

3. Right-click the configured disk’s unallocated space and select **New Partition**. If the New Partition option is not available, select the disk and initialize it first. To do this, right-click on the disk item and select "Initialize Disk".

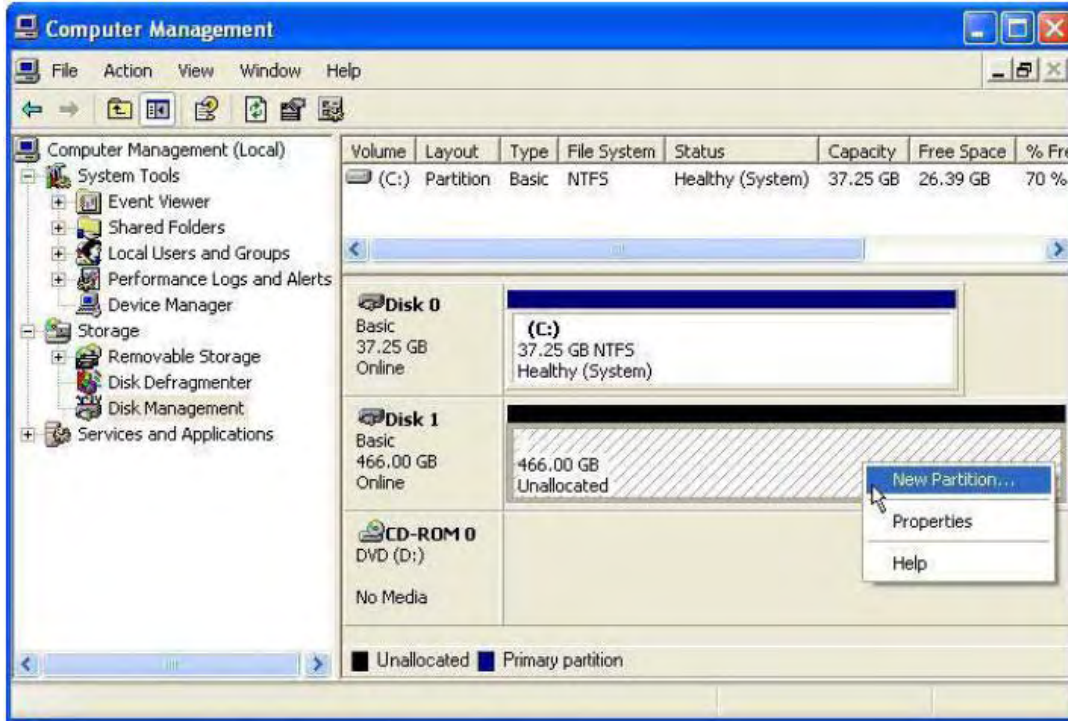

4. Click **Next** to start the Partition Wizard.

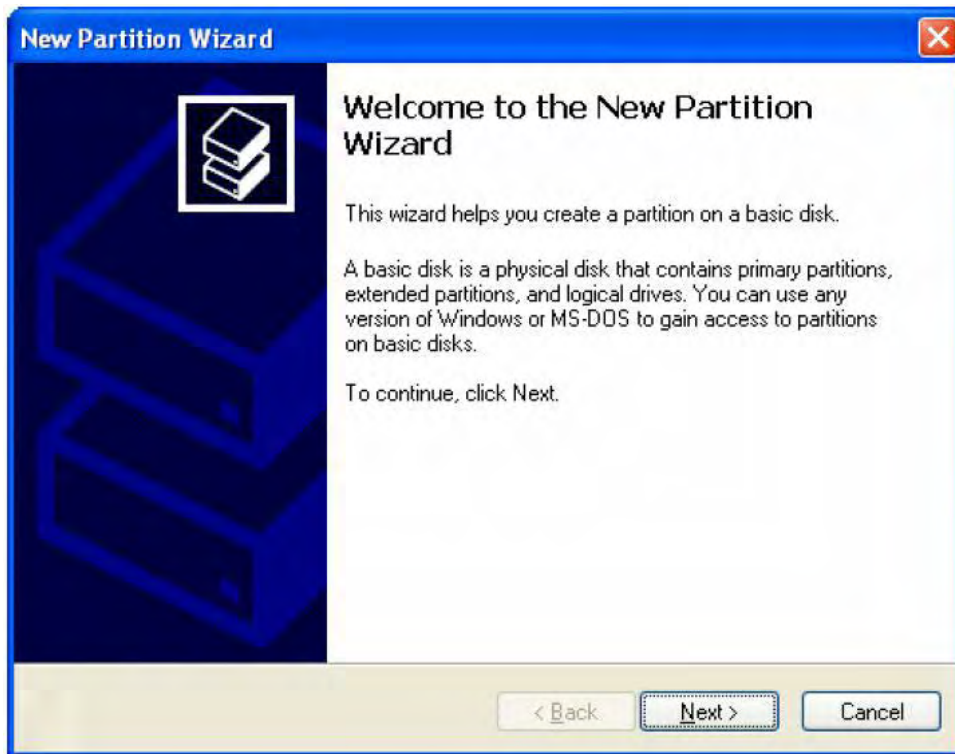

5. Select the Primary or Extended option and click **Next**.

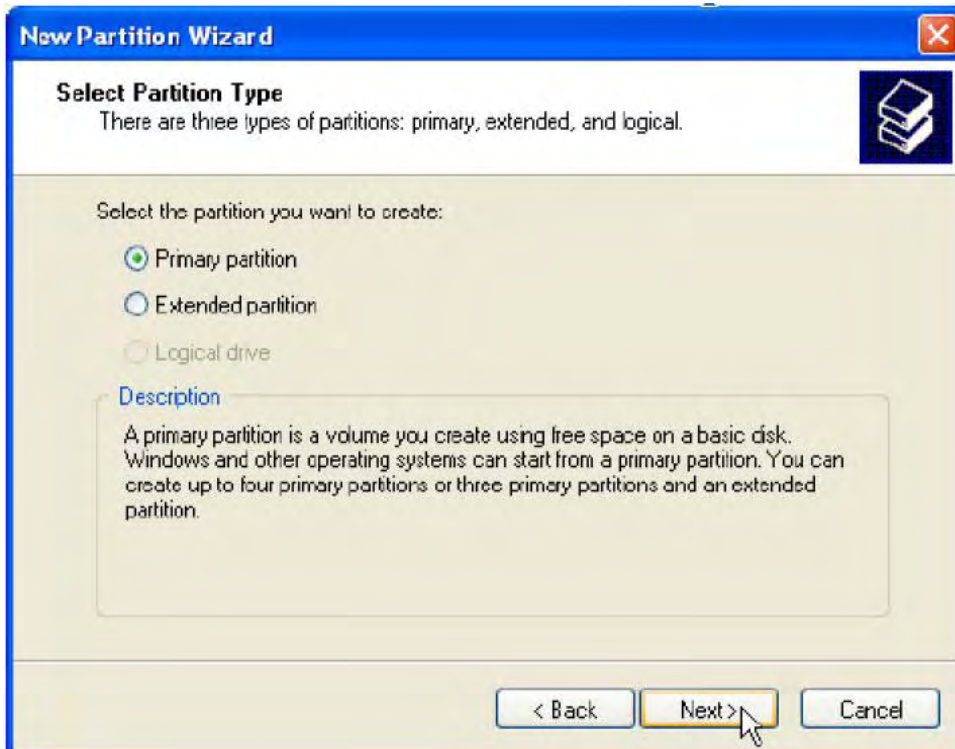

6. Specify the partition size. By default, the partition occupies the entire volume. Click **Next**.



7. Assign a drive letter or mount path and click **Next**.



8. Name and format the partition and click **Next**.

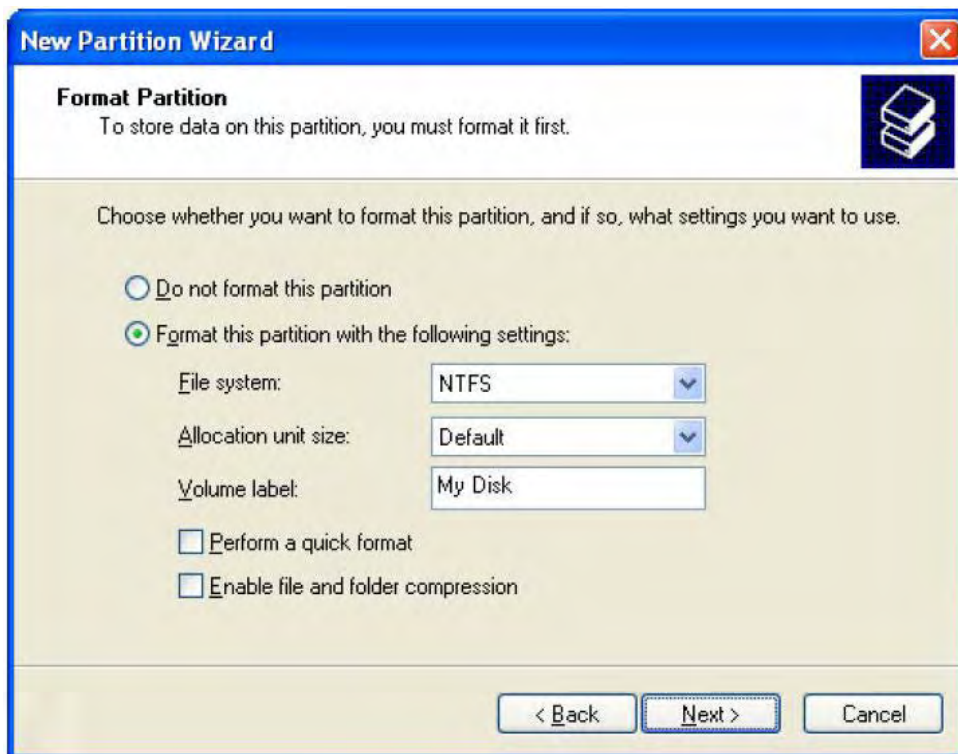

9. Review the file system settings and click **Finish** to create the logical partition.

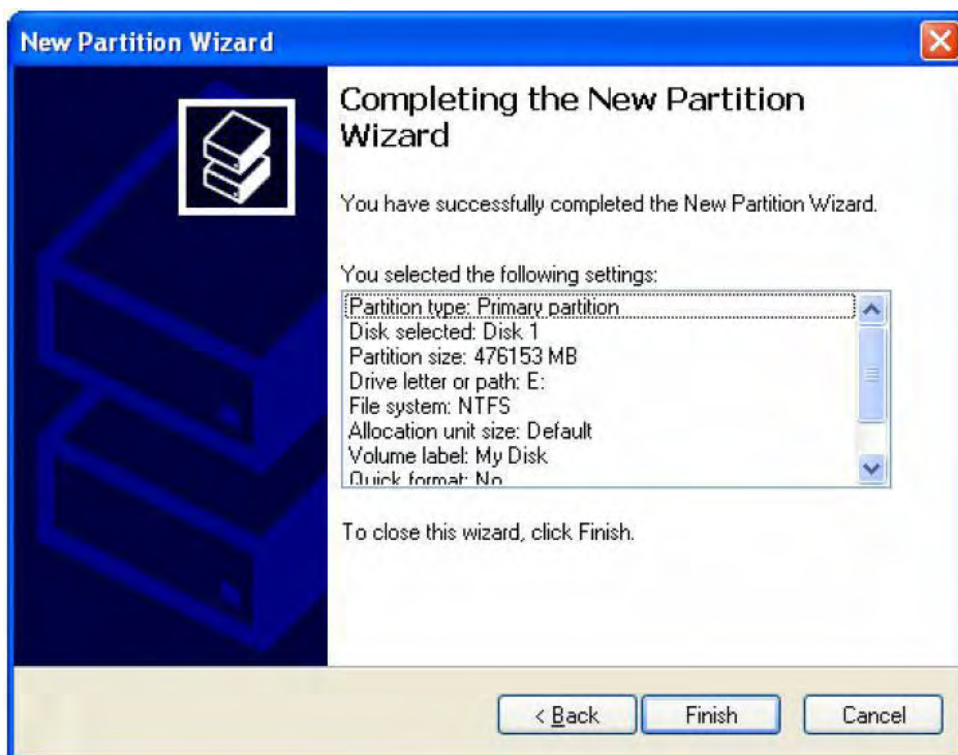

10. Repeat steps 1 through 9 to partition any remaining disks.

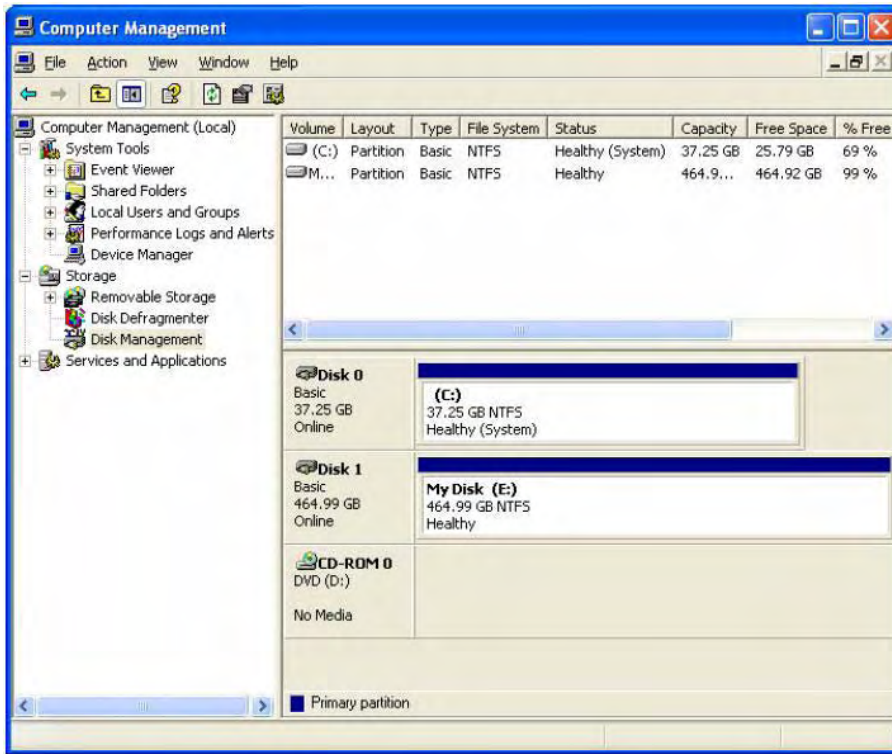

### 5.1.2 MACINTOSH SYSTEMS

**Note:** Before reconfiguring a volume, back up your data and drag the old drive to the trash to un-mount previously partition. After you configure and partition the new volumes, restore the backed-up data to the new configuration.

1. Launch **Disk Utility** from the **Application > Utilities** folder.

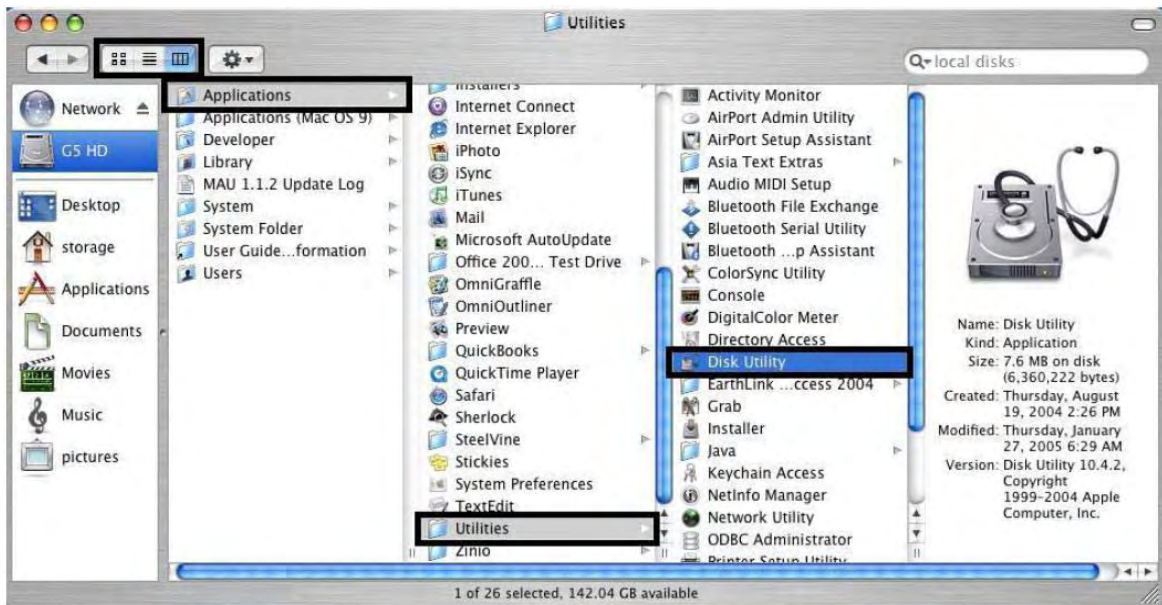

2. Select a configured disk and click the Partition tab. This procedure illustrates the **LARGE** Storage Policy configuration, which concatenates the capacity of all hard drives connected to the **TERA STOR SATA RAID III**.

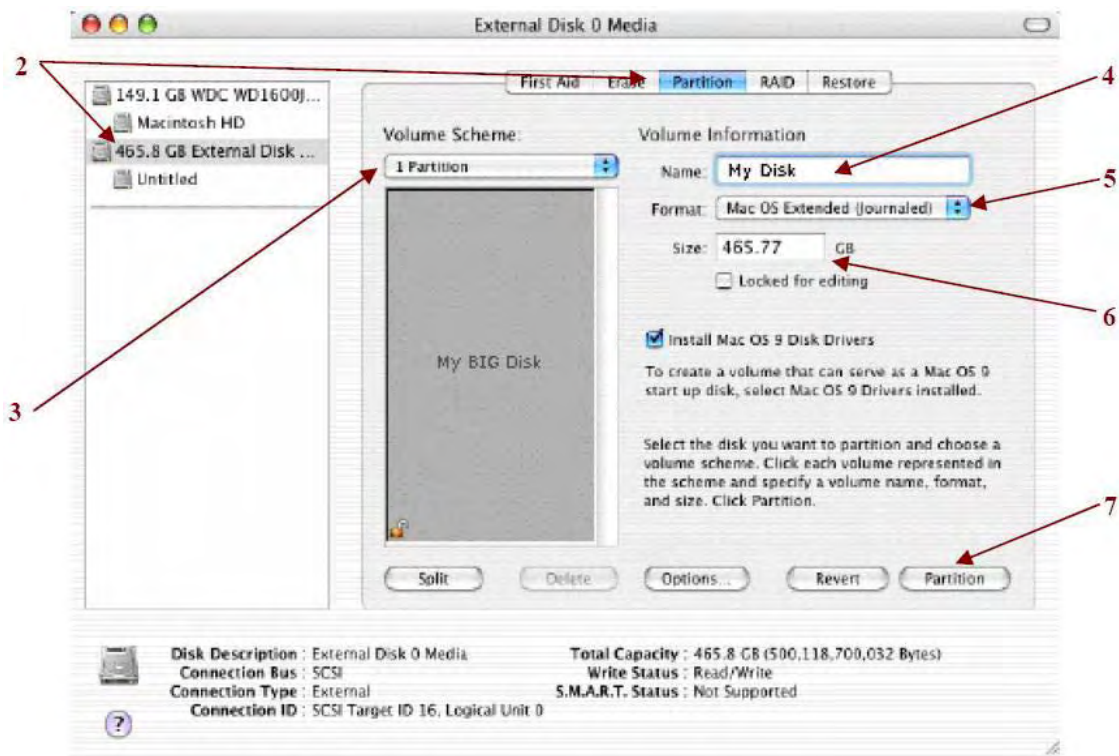

3. Select **1 Partition** from the **Volume Scheme** drop-down list.
4. Enter a name for the volume in the **Name** field (such as “My Disk”).
5. Select **Mac OS Extended (journaled)** from the **Format** drop-down list.
6. Specify the size of the partition in the **Size** field.
7. Click the **Partition** button.
8. Click **Partition** to acknowledge the warning.

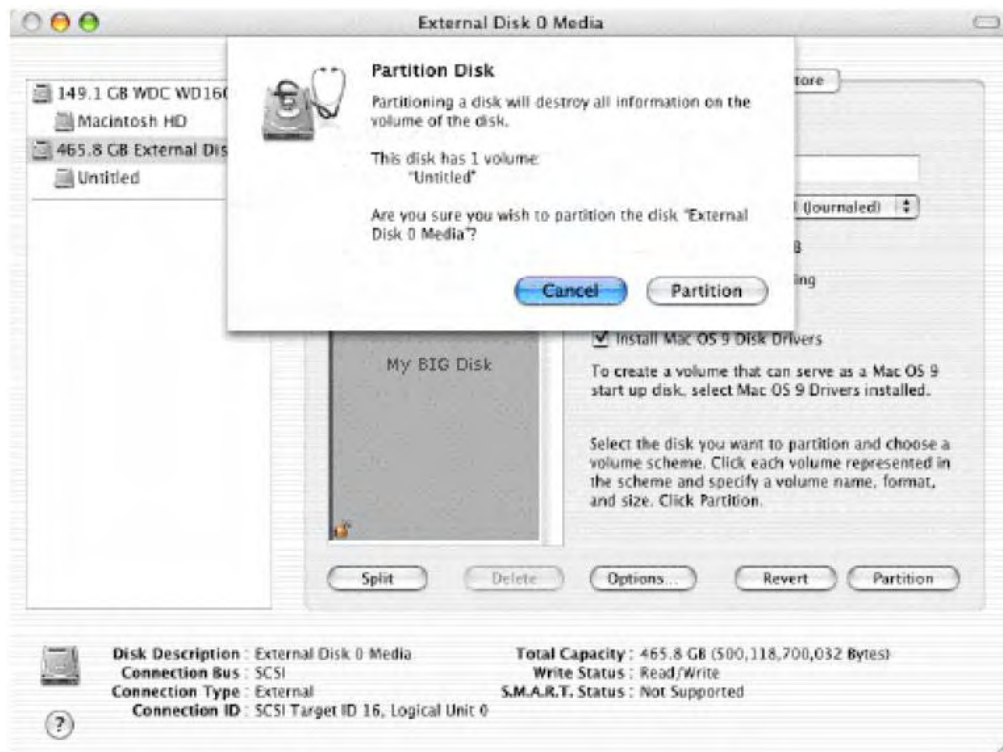

Disk Utility mounts the created partition and represents it with an icon on the desktop. The icon is labeled

- 
- with the partition name.
9. Repeat steps 1 through 8 to partition any remaining disks you configured.

# 6 APPENDIX

## 6.1 FAQ

If you need some help for troubleshooting, please check the frequently asked question below, it may help you problem solved quickly

- **Can not recognize**
  - Make sure all cables have been connected properly.
- **Can not operate in O/S**
  - Make sure the O/S is support for the product.
- **Transmission speed is slow**
  - If connect USB1.1 interface, the speed will be around 1MB/sec only.
- **When format in the Windows XP/ Vista/ 7 RC2, the dialog box appear “Unfinished formatting”**
  - Windows XP/ Vista/ 7 RC2 can not format HDD over 32GB by FAT32, Please format by NTFS ◦
- **When using different capacity or brand HDD, can we still using COMBINE mode ?**
  - Yes
- **When system is damaging on LARGE mode, is it possible to keep the data?**
  - No. The system is different with RAID, the entire disk can not be read.

## 6.2 HARD DISK DRIVE COMPATIBILITY LIST

The TOWER RAID TR5UT(-B) Storage Appliance has been tested compatibility with a range of drive manufacturer and size. The table is updated as new disk drives are certified for compatibility. Only disk drives included in this table are supported.

Manufacturer	Capacity	Family	Part Number	Firmware
Fujitsu 2.5"	320GB	N/A	MH2232DBH	00000009
Fujitsu 2.5"	160GB	N/A	MHW2160BH	00000009
Fujitsu 2.5"	160GB	N/A	MHZ2160BH	00000009
Fujitsu 2.5"	120GB	N/A	MHY2120BH	0000000B
Fujitsu 2.5"	80GB	N/A	6D005	00000028
Fujitsu 2.5"	60GB	N/A	MHY2060BH	0000000B
Hitachi	2000GB	Deskstar™ 7K2000	HDS722020ALA330	JKAOA20N
Hitachi	1000GB	Deskstar™ 7K1000	HDS721010KLA330	GKA0AB0A
Hitachi	500GB	Deskstar™ P7K500	HDP725050GLA360	GMOA52A
Hitachi	500GB	Deskstar™ P7K500	HDP725025GLA360	GM40A52A
Hitachi	500GB	Deskstar™ P7K500	HDT725025VL360	V560A52A
Hitachi	320GB	Deskstar™ P7K320	HDT725032VLA360	R22L9YDN
Hitachi	320GB	Deskstar™ P7K320	HDP725032GLA360	GM30A52A
Hitachi	320GB	Travelstar™ 5K320	HTS543232L9A300	FB40L40C
Hitachi	250GB	Deskstar™ P7K250	HDP725025GLA380	GM20A52A
Hitachi	250GB	Deskstar™ T7K250	HDT722525DLA380	V440A9BA
Hitachi	250GB	Deskstar™ 7K250	HTS54252K9SA00	BBFOC31P
Hitachi	160GB	Deskstar™ 7K80	HDS72180PLA380	P22OABEA
Hitachi	160GB	Deskstar™ 7K160	HDS721616PLAT80	P22OABEA
Hitachi	80GB	Deskstar™ 7K160	HDS721680PLA380	P210A70A
Hitachi	80GB	Travelstar™ 5K100	HTS541080G9SA00	MB40C60R
Hitachi	80GB	N/A	HDD725050GLA360	GM40A50E
Hitachi 2.5"	100GB	Deskstar™ 7K200	HTS722010K9SA00	DC20C76A
Maxtor	750GB	DiamondMax® 22	STM3756330AS	MX15
Maxtor	500GB	DiamondMax® 22	STM3500320AS	MX15
Maxtor	320GB	DiamondMax® 21	STM3320620AS	3.AAE
Maxtor	300GB	DiamondMax® 10	6L300S0	BANCIG10
Maxtor	250GB	DiamondMax® 21	STM3250310AS	3.AAF
Maxtor	250GB	DiamondMax® 10	6V250F0	VA222900
Maxtor	250GB	MaxLine® III	7V250F0	VA111670
Maxtor	200GB	DiamondMax® 10	6V200E0	VA111900
Maxtor	160GB	DiamondMax® 21	STM3160815AS	4.AAB
Maxtor	80GB	DiamondMax® 10	6V080E0	VA111900

Samsung	1000GB	SpinPoint™ FI	HD103UJ	IAG01113
Samsung	400GB	SpinPoint™ T133	HD400LJ	22100-15
Samsung	250GB	SpinPoint™ S250	HD250HJ	FH100-06
Samsung	250GB	SpinPoint™ S250	HD250HJ	01.03A01
Samsung	80GB	N/A	SP0812C	SU100-34
Seagate	1500GB	Barracuda® 7200.11 SATA	ST3150031AS	SD17
Seagate	1500GB	Barracuda® 7200.11 SATA	ST31500341AS	SD17
Seagate	1000GB	Barracuda 7200.11 SATA 3Gb/s	ST31000340AS	SD15
Seagate	1000GB	Barracuda® ES2	ST31000340NS	SN04
Seagate	750GB	Barracuda® 7200.10	ST3750640AS	3.AAC
Seagate	750GB	Barracuda® ES2	ST3750330NS	SN04
Seagate	640GB	Barracuda 7200.12 SATA 3Gb/s	ST360323AS	SD35
Seagate	500GB	Barracuda® ES	ST3500630NS	SN04
Seagate	500GB	Barracuda 7200.11 SATA 3Gb/s	ST3500320AS	SD15
Seagate	400GB	Barracuda® 7200.10	ST3400620AS	12.01B01
Seagate	320GB	Barracuda® 7200.10	ST3320620AS	3.AAK
Seagate	320GB	Barracuda® 7200.11 SATA 3Gb/s	ST3320613AS	SD22
Seagate	250GB	Barracuda® ES	ST3250620NS	3.AEG
Seagate	250GB	DiamondMax® 21	STM3250310AS	3.AAF
Seagate	250GB	Momentus® 5400.4 SATA	ST9250827AS	3.AAA
Seagate	250GB	N/A	ST9200820AS	3.AAA
Seagate	200GB	N/A	ST9200820AS	AKL2YK
Seagate	160GB	Barracuda 7200.10 SATA 3Gb/s	ST3160815AS	4.AAB
Seagate	160GB	Barracuda 7200.10 SATA 3Gb/s	ST3160815AS	3.AAD
Seagate	160GB	Barracuda® 7200.7 Serial ATA	ST3160827AS	3.42
Seagate	160GB	SV35	ST3160812SV	3.ALP
Seagate	80GB	Momentus® 5400.3 SATA	ST980811AS	3.ALC
Seagate	80GB	DiamondMax® 10	6V080E0	3.AAD
Seagate	60GB	Momentus® 5400.2	ST96812AS	3.06
Seagate 2.5"	120GB	N/A	ST9120822AS	3.ALC
Toshiba 2.5"	320GB	N/A	MK3252GSX	LV010D
Toshiba 2.5"	250GB	N/A	MK2546GSX	LB012D
Toshiba 2.5"	160GB	N/A	MK1637GSX	DL050I
Toshiba SSD 2.5"	128GB	N/A	THNS128GE8BBDC	T1020061
Western Digital	2000GB	WD Caviar® Green	WD20EADS-00R6B0	N/I
Western Digital	1000GB	WD Caviar® Green	WD10EACS-00Z1B0	1AA01113
Western Digital	1000GB	WD Caviar® RE2-GP	WD1000FYPS-012KB0	02.01B01
Western Digital	1000GB	WD Caviar® Black	WD1001FALS	02.01B01
Western Digital	1000GB	WD Caviar® RE-3	WD1001FYPS	02.01B01
Western Digital	640GB	WD Caviar® Blue	WD6400AAKS-00A7B0	01.03B01
Western Digital	500GB	WD Caviar® Black	WD5000AALS-002UB0	01.01B01
Western Digital	500GB	N/A	2F002	01.01A01
Western Digital	400GB	WD Caviar® RE2	WD4000YR-01PLB0	D1.D6AD1
Western Digital	400GB	WD Caviar® SE16	WD4000AAKS-00TMA0	12.01C01
Western Digital	320GB	WD Caviar® Blue	WD3200AAJS-22RYA0	D5.D6H05
Western Digital	320GB	WD Caviar® RE2	WD3201ABYS-01B9A0	13.01C02
Western Digital	320GB	WD Caviar® SE	WD3200KS-00FB0	21.0DM21
Western Digital	320GB	WD Caviar® Blue	WD3200AAJS-00LSA0	12.01B01
Western Digital	320GB	WD AV	WD3200AVJS-63VDA0	12.01B02
Western Digital	300GB	WD VelociRaptor	WD3000GLFS-01F8U0	03.03V01
Western Digital	250GB	WD Scorpio® Blue	WD2500BEVS-60VST0	01.01A01
Western Digital	250GB	WD Caviar® Blue	WD2500AAKS-00B3A0	FH100-06
Western Digital	250GB	WD Caviar® RE	WD2500YS-01SHB1	2D.06CD6
Western Digital	160GB	WD Caviar® RE2	WD1601ABYS-01C0A0	06.06H05
Western Digital	160GB	WD Scorpio® Blue	WD1600BEVS-60RST0	04.01G04
Western Digital	160GB	WD Caviar® Blue	WD1600AAJS-22PSA0	05.06H05
Western Digital	160GB	WD Caviar® Blue	WD1600JS-22MHB0	02.010C3
Western Digital	150GB	WD Caviar® Blue	WD1500AHFD-00RAR0	19.06P19
Western Digital	100GB	WD Scorpio® Blue	WD1000BEVS-22LAT0	01.06M01
Western Digital	80GB	WD Caviar® Blue	WD800AAJS-00PSA0	D5.06H05
Western Digital	80GB	WD Caviar® SE	WD800JD-00M8A1	10.01E01

Table last updated October 2009.

## 6.3 MOTHERBOARD COMPATIBILITY LIST

The TowerRAID TR5UT/TR5UT-B storage Appliance has been tested compatibility with a range of motherboard manufacturer. The table is updated as new motherboards are certified for compatibility. Only motherboards included in this table are supported.

Manufacturer	Product	North Bridge	South Bridge	BIOS
ABIT	IP-95 V1.0	VIA P4M890	VIA VT8237R	IP-95
ASUS	M2R32-MVP	AMD5180	ATI SB600	0712
ASUS	M3A78 PRO	AMD 780GX	ATI SB700	0202
ASUS	M3A78-T	AMD 790GX	ATI SB750	0204
ASUS	P4P800-X	INTEL 865PE	INTEL ICH5	1009
ASUS	P4P800	INTEL 865PE	INTEL ICH5R	1019
ASUS	P5GD1 PRO	INTEL 915P	INTEL ICH6R	1004
ASUS	P5LD2-X/I333	INTEL P945GC	INTEL ICH7	0115
ASUS	P5GZ-MX	INTEL 945GZ	INTEL ICH7	0801
ASUS	P5LD2	INTEL 945P	INTEL ICH7R	N/I
ASUS	P5WDG2WS PRO	INTEL 975X	INTEL ICH7R	0905
ASUS	P5B	INTEL P965	INTEL ICH8	1102
ASUS	P5B-VM	INTEL G965	INTEL ICH8	N/I
ASUS	P5K SE	INTEL P35	INTEL ICH8	1008
ASUS	P5D DELUXE	INTEL 965	INTEL ICH8R	1236
ASUS	P5B-E	INTEL P965	INTEL ICH8R	1803
ASUS	P5KR	INTEL P35	INTEL ICH9R	0605
ASUS	P5QL PRO	INTEL P43	INTEL ICH10	N/I
ASUS	P5Q PRO	INTEL P45	INTEL ICH10	0003
ASUS	P5Q PRO	INTEL P45	INTEL ICH10	1460
ASUS	M2NC51-AR	NVIDIA NFORCE 410 MCP	MCP43	N/I
ASUS	M2NC51-AR	NVIDIA NFORCE 430 MCP	MCP43	N/I
ASUS	M2N-SLI DELUXE	NVIDIA NFORCE 570 SLI MCP	MCP55	1604
ASUS	M2N-MX	NVIDIA NFORCE 430	NFORCE4	N/I
ASUS	M2N-MX	NVIDIA GEFORCE 6100	NFORCE4	N/I
ASUS	P5N-E SLI	NVIDIA NFORCE 650I SLI	NFORCE6	1101
ASUS	M3N78-EH	NVIDIA NFORCE 730A	MCP78	0412
ASUS	P4S800D	SIS 655FX	SIS964	1012BETA003
ASUS	P5V800-MX	VIA P4M800	VIA VT8251	0802
ECS	761GXM-MV1.0	SIS 761GX	SIS 966L	02.21.2008
GIGABYTE	MA78GM-S2H	AMD780G	ATI SB700	F5
GIGABYTE	GA-GC230D	INTEL 945GC	INTEL ICH7	F1
GIGABYTE	GA-8I945PLG	INTEL 945PL	INTEL ICH7	F8
GIGABYTE	GA-P35-DS3X	INTEL P35	INTEL ICH9	V1.7060508
GIGABYTE	GA-EP45-DS3	INTEL P45	INTEL ICH10	F6
GIGABYTE	GA-EX58-UD3R	INTEL X58	INTEL ICH10R	FB
GIGABYTE	GA-73PVM-S2H	NVIDIA GEFORCE 7100	MCP73	F7A
GIGABYTE	GA-M78SM-S2H	NVIDIA GEFORCE 8200	NVIDIA GEFORCE 8200	F1
MSI	K9AG NEO2-DIGITAL	AMD 690G	ATI SB600	N/I
MSI	P35D3 PLATINUM	INTEL P35	INTEL ICH9R	V1.062807
MSI	K8N-NEO4H	NVIDIA NFORCE4 ULTRA	NFORCE4	V7.0020906
MSI	K9N4 SLI	NVIDIA NFORCE 500 SLI	NFORCE5	N/I
INTEL	D945GCLF2	INTEL 945GC	INTEL ICH7	LF94510J
INTEL	D201GLY2A	SIS 662	SIS 964	LY66210M

Table last updated October 2009.